

Farms.com™

BUYER'S AgGUIDE



www.farms.com/UsedFarmEquipment

FARMS.COM RISK MANAGEMENT 2016
5TH ANNUAL CROP TOUR REVIEW *Special Section*



STANDARD FEATURES

- Powder Coat Paint Finish - Interior & Exterior
- Telescopic Ladder
- 25" Spring Loaded Vented Lid
- 24" Clearance Under Bottom Side
- Rack & Pinion Slide Gate



Serving all of Ontario



THE RESULT...

- A Higher Quality Grain
- Increased Test Weight
- The Lowest Energy Cost per Bushel
- Capable of Drying Virtually any Type of Commodity



Arthur, Ont
519-848-3209

Email: candadistributing@gmail.com





Husky Farm Equipment Ltd

Committed To Quality You Can Depend On!



- Also Available
- Lagoon Pumps
- 10-12" Pipe Carts
- Truck Mounted Tanks
- Wireless Remote Controls

A Complete Line Of Liquid Manure Handling Equipment
husky@huskyfarm.ca 519-846-5329 www.huskyfarm.ca



**Storage Buildings Garages Backyard Sheds Livestock Shelters
RV Shelters Greenhouses Hanley Tunnels Pool Enclosures
Airplane Hangars Salt & Sand Storage Boat Shelters....And more!**

10'-36' wide, any length you need

Is Mother Nature being a Challenge?



**We have your
Shelter Solution!**

STORAGE BUILDINGS

30' x 60' x 15' - **\$5,652**
24' x 72' x 13'2" - **\$5,279**
20' x 48' x 12'1" - **\$3,182**
16' x 36' x 11'3" - **\$2,299**

Prices include 12 mil woven tarp for roof & ends, all steel & hardware required

Sample pricing shown as examples
Call for your custom quote!

GREENHOUSES

30' x 96' x 15' - **\$7,508**
27' x 72' x 11'7" - **\$5,043**
20' x 48' x 9'8" - **\$2,818**
16' x 36' x 8'10" - **\$2,144**

Prices include double plastic & roll up sidewalls & all steel & hardware required

Manufactured & Distributed from Palmerston, ON



Canadian Made for Canadian Climates

MultiShelterSolutions.com

1-866-838-6729 multisheltersales@gmail.com



Spa Covers

These structures are great for season extending, lowering maintenance time, maintaining heat and privacy

Upcoming Shows

July 31-Aug 1
Georgian Homesteading Show Markdale, ON
Aug 24-25
Hastings County Farm Show Queensborough, ON
September
Outdoor Farm Show Woodstock & IPM Harriston

Due to our busy & limited staff, **Shop Visits are by Appointment ONLY** to ensure you receive the help you need!
Please see website for complete list of exclusions Supplied as kits for customer assembly

Tubeline BaleWrappers provide a fast and efficient way to get hay off the field and put up high quality silage. Allowing producers to deliver the nutrient rich, palatable, easily digestible hay that your dairy or cattle herds crave.



^ TL1000R
Round Bale



^ TLR5000ECV
Round Bale



^ TL5500ECV
Round & Square Bale



^ TL6500ECV
Round & Square Bale

WRAPPERS & SPREADERS

Nitro spreaders are constructed with top grade materials to handle real day-to-day farming. Now available with optional poultry beater assemblies, Nitro spreaders make it easy to put litter in its place.



^ Nitro375RS
12 Ton



^ Nitro525RS
15 Ton



^ Nitro450
13 Ton



^ Nitro600
17 Ton



^ Nitro750
20 Ton



^ Nitro950
25 Ton

NITRO RS

NITRO

TUBE•LINE™

www.tubeline.ca

1.888.856.6613

NORTH WELLINGTON LIFTRUCK



THE AREAS LARGEST ONSITE LIFTRUCK INVENTORY

Repairs & Parts To All Makes & Models
Large Selection of Rental Units Available

BATTERY REPAIR & SALES LARGE INVENTORY OF NEW INDUSTRIAL BATTERIES



2010 TOYOTA 4000LB

outdoor, 3-stage, side shift
\$15,500



2005 TOYOTA 5000LB

outdoor, 3-stage mast, side shift
\$12,900



2011 TOYOTA 6000LB

indoor, 3-stage mast, side shift
\$13,900



HYSTER 4000LB

outdoor, electric, 3-wheeler, 3-stage mast, side shift, 36 volt
\$10,000



KOMATSU 6000LB

outdoor, 3-stage mast, side shift
\$8,000



2013 TOYOTA 3500LB

indoor, 3-stage mast, side shift fork positioner
\$14,900



2016 EAGLE PALLET TRUCK

new, 3000 lb capacity, compact, comes with onboard charger
\$3,250



2004 YALE 4000LB

outdoor, 2-stage mast, 1919 hours
\$11,000



2011 TOYOTA 5000LB

indoor, 3-stage mast, side shift
\$15,000



2007 TOYOTA 4000LB

indoor, 3-stage mast, side shift
\$13,500



2006 CROWN REACH TRUCK

3-stage mast, side shift, 5915 hours, 36 volt batter
\$10,500



2011 TOYOTA 5000LB

outdoor, 3-stage mast, cab, side shift, 2340 hours
\$21,900



1998 NISSAN 8000LB

indoor, 3-stage mast, side shift, 11854 hours
\$6,500



1994 TOYOTA 6000LB

outdoor, 3-stage mast, side shift,
\$9,500



CLARK 3500LB

outdoor, 3-stage mast
\$6,000



2007 TOYOTA 15,000LB

outdoor, 2-stage mast, side shift, fork positioner
\$29,000



2008 TOYOTA 6000LB

outdoor, 3-stage mast, side shift, 20284 hours
\$12,000



1999 TOYOTA 5000LB

outdoor, 3-stage mast, side shift
\$10,500



2009 TOYOTA 6500LB

outdoor, 2-stage mast, side shift, fourth valve, 6653 hours
\$17,900



POLARIS SPORTSMAN 800

2014, 635 miles
\$8,500

www.northwellingtonliftruck.com



DOWNLOAD OUR MOBILE APP

p 519.848.3504 | f 519.848.2679 | RR 2, Arthur Ontario

EkotuningCom
THE USEFUL POWER

Mobile
PTO Tractor
Dyno For
Proven
Results



T. CHRISTIE
REPAIR & PERFORMANCE

Contact T. Christie Repair & Performance with all your tuning inquiries

t. 519.476.3241 e. tcperformance@quadro.net

QC TX



PTO GENERATORS 7-100 KW

8 WEEKS 8% SAVES YOU 8%

Pre-order your Baumalight generator now for delivery in 8 weeks and get an 8% discount for planning ahead.

Call, click or see dealer for details.



1-866-820-7603

BAUMALIGHT.COM

BAUMALIGHT™



Stump Grinders



PTO Power Packs



Mulchers

ECC16494-S01

ATV

KW Honda	84
Polaris	73

Auctions

Shackelton Auctions	26
---------------------	----

Barn/Livestock Equipment

Bauman Mfg	41
Davon Sales Inc.	27
D.M. Horst & Sons Ltd.	44
E.S. Martin Welding	16
Marweld	32
McIntyre Welding	62
Nu-Matic Spread-Rite	32

Building & Building Supplies

Access Storage	28
ANS Doors Inc.	20
Blue Metal Industries	67
Britespan Building Systems	15
Calhoun Super Structures Ltd.	33
Clark's Mobile Homes	36
Davon Sales Inc.	27
Dundalk Windows & Doors	34
Glenvalley Construction	47
Insta-Insulation	23
iPoly	72
L&R Shelters	37
Linwood Industrial Corp.	17, 62
Mega Dome	14
Multi Shelter Solutions	3
National Building Group Inc.	76
Omni Structures	56
Pioneer 1 Steel Buildings	77
Plas-Tech Inc.	58
Ridgeway Metal Forming	80
Seatiner Terminals Inc.	64
South Shore Homes	48
Tasco Dome	Insert

Drainage Contractors

Envir-O-Site Inc.	64
Martin Drainage	26

Forestry & Woodlot

Baumalight MTB	6
CENTRAL BOILER - Country Heat	67
CENTRAL BOILER - Wood Heat Solutions	22
EMB Manufacturing	47
Friesen Built	58
Grain Stoves Inc.	48
Green Valley Heating	79
Heat Master	20
L.P. Wood Heating Systems	34
Maple Valley Sales	8
Marvara Farms Ltd.	53
Portage & Main Boilers	29
Split-Fire Sales Inc.	30
Urecon Limited	29
Wood Master of Canada	78

Generators/Solar Power

Baumalight MTB	6
H. Broer Equipment	60

Grain & Feed Handling

Bach-Run Farms	Insert
Bulk Tech	24
C & A Distributing	Cover
Nu-Matic Blow-Rite	50
Smith Steel	19
Vertablend	28

Hay and Forage

Bach-Run Farms	Insert
Creekbank Welding	38
Horst Welding	69
Longhaul Trailer Sales	45
Mar-Ilo Fabricating	11
Marccrest Manufacturing Inc.	12
Martin Farm Wagons	53
Smyth Welding	60
Tube-Line Manufacturing	4

Lawn/Garden/Power

Big Dog Mower Co.	84
Briggs & Stratton	131
Delaware Pump & Parts	18
Easy-Kleen	18
Echo Power Equipment	39
Envir-O-Site Inc.	64
ESB Aluminum Products	72
Fish Farm Supply	25
H. Broer Equipment	60
Hustler Lawn Mowers	21
Husqvarna Corporation	51
Karcher Wash Systems	76
Longhaul Trailer Sales	45
Maple Valley Sales	61
May-Bridge Harrows	50
Makita Canada	73
Neilman Construction	76
Pond Perfections	13
Silvercreek Aquaculture Inc.	65
Zehr's Sales & Mfg.	83

Manure & Chemical

Bach-Run Farms	Insert
Delaware Pump & Parts	18
Husky	2
James K. Bauman	80
Nuhn Forage Inc.	22
Pichon	36
Stratford Ag Analysis	53
Tube-Line Manufacturing	4
Wayne Martin	58

Parts & Repairs

Country Air	86
Eldale Machine	26
Home of Spare Parts	85
MarTarp	68
North Wellington Lift Truck	5
T. Christie Equipment Repair & Performance	6
Trakar Products Inc.	40

Planting, Seeding & Tillage

Argis 2000 Ltd.	Insert
Eastern Farm Machinery	70
Elmer's Flighting Supply	28
Kearney Planters	75
Mar-Ilo Fabricating	11
May-Bridge Harrows	50
Rite-Way	Insert
Smyth Welding	60
Stoneage Equipment	54, 55
Sunflower	57
Weberway Inc.	38
Wil-Rich	Insert

Real Estate/Mortgage Brokers/ Financial Services

Alister MacLean	93
CVE Mortgage Group Inc.	91

Expert Mortgage	81
Farm Ontario	92
Farms.com Real Estate	96, 97
Glen Reay	92
Igor Poliszczuk	94
Ivan Alderdice	94
Just Farms	90
Justin Deseck	93
Marg McCarthy	92
Ontario Farm Group	93
Your Farm Connection	94

Skid Steers/Attachments

Gehl	30
------	----

Tires

Bach-Run Farms	Insert
Home of Spare Parts	85
OK Tire & Auto Service	24

Tractors & Attachments

Deboer's Farm Equipment	86
Fendt	62
H. Broer Equipment	60
Kioto Tractor	10
Kubota	35
Landini Canada Inc.	56
Lawlor Haulage Ltd.	87
LS Tractor	59
Massey Ferguson	44
Maxwell Farm Service	87
McCormick Canada Inc.	40
Scholten's Machinery	68
Shantz Farm Equipment	12
Stoneage Equipment	54, 55

Trailers

Action Trailers	9, 86
Belore Trailers	14
Canada Trailers	43
Jensen Trailers	132
Jim Bray Trailers	68
Miska	31
PJ Trailers	63
Trailers Plus	19
Transit Trailers Limited	49
Zehr's Sales & Mfg.	83

Trucks

Arthur Chrysler	71
Lawlor Haulage Ltd.	87
T. Christie Equipment Repair & Performance	6



SPECIAL U.S. CORN BELT CROP TOUR INSERT

See centre section

Argis 2000 Ltd
Bach-Run Farms
Rite-Way
Tasco Dome
Wil-Rich

Classifieds 866-519-4302

To Advertise Call:

Southwestern & Eastern Ontario
(up to Kingston)

Jeff Scott, cell 905-933-6493

Western & Eastern Ontario

Scott Farhood, cell 519-616-2836

Real Estate & Inside Sales

Ann Hepburn, cell 519-803-7578

Contact Us:

52 Royal Road, Unit A, Guelph, ON N1H 1G3
Phone Numbers: 519-763-9660 • 866-519-4302
Fax Number: 1-800-471-0799

Email: agbuyersguide@farms.com

Accounting: 866-519-4302

Manager **Diane Houlachan**
905-517-4772 or 866-519-4302 x276

DEADLINE FOR SEPTEMBER IS AUGUST 17, 2016

Farms.com Ag Buyer's Guide is published twelve times a year and is delivered free to rural farmer mailboxes in Ontario. Farms.com Ag Buyer's Guide is not responsible for any mistakes, misprints, or typographical errors. Farms.com - Ag Buyer's Guide is diligent in checking all advertising copy for any errors, but no guarantee is given or implied by the publisher.

© 2016

Published by: Farms.com Canada Inc.

Maple Valley Sales & Service

793175 County Rd. 124 Creemore, ON L0M 1G0

PH: 705-466-3138 FAX: 866-234-5305

Email: sales@maplevalleysales.com www.maplevalleysales.com



LX115/LT60
Log Boom & Hwy Trailer



BX72R
3ph 7' Wood Chipper



LX5200
Skid Steer Log Grapple



LX95/LT30
Log Boom & Off Road Trailer



BXM32
3ph 3' Wood Chipper Shredder



BXM47
3ph 4' Wood Chipper Shredder



BXT6238
6' Trail Wood Chipper



BX1028P1
3ph 10' Wood Chipper



GX720 Backhoe Attachment



WHS14000
Generator 14000watt

WALLENSTEIN

WE NOW CARRY AN EXCLUSIVE LINE OF WALLENSTEIN DEMO UNITS & REFURBISHED PRODUCTS.

CALL US TODAY AT 705-466-3138 FOR HUGE CASH SAVINGS

ALL UNITS HAVE 1 YEAR WARRANTY SOME UNITS COME WITH 3 YEAR WARRANTY.

Demo and refurbished items in stock

MAPLE VALLEY DEAL OF THE MONTH BACKHOE ATTACHMENT



GX920 Backhoe Attachment

WALLENSTEIN



GX920XT Backhoe Attachment



BXC32
3' Wood Chipper



BX1025
Wood Chipper



FX06
3ph Logging Winch



FX110
3ph Logging Winch



BK52R
3ph 5' Wood Chipper



BXC32
3' Wood Chipper



WXR740
Wood Splitter

Hours: Monday - Friday 8 to 5, Saturday 9 to 12, Sunday closed



1-866-885-2569
www.actiontrailers.ca



Check us out online to see what's currently in stock.
 UPDATED DAILY WITH PICTURES AND PRICING.

2017 QUALITY 6 X 12' - 5 TON with NEW COMBO GATE

New combo barn door/ramp gate design makes loading equipment much easier and it is much safer than loading with two separate ramps.

Upgraded features built onto this model:

- Tarp kit with steel casing
- LED light pkg all around
- Larger tool box with partition wall
- 4 welded on tie-downs
- Dual piston or telescopic piston
- 12' OC cross member upgrade on bed

EASIER TAIL GATE OPERATION THAN OUR COMPETITION



\$7399 \$160 MONTHLY \$0 DOWN O.A.C. (Reg \$7991)

2017 NEO ALL ALUMINUM MOTORCYCLE TRAILER 5' X 9'

- SIDE ACCESS DOOR WITH RV FLUSH LOCK DOOR HANDLE
- REAR RAMP GATE WITH SPRING ASSIST
- 6' ADDITIONAL HEIGHT TO MAKE IT 5'5" INTERIOR FOR FULL SIZE BIKES TO FIT IN
- 15" WHEELS WITH SILVER RIMS
- TAPERED V-NOSE WITH HIGHER STONE GUARD UPGRADE



\$3698
 (Reg \$3898)
THIS MONTH ONLY DON'T MISS OUT ON THIS SALE

2017 EQUIPMENT 7 TON LOW PROFILE 83' X 18'

- EXPANDED METAL OVER RAMPS
- 6 WELDED ON D-RINGS
- REMOVABLE FENDER UPGRADE
- LED LIGHTS ALL AROUND
- SLIPPER SPRING SUSPENSION
- SPRING ASSISTED RAMPS
- 3YR WARRANTY



\$5199
 \$114 MONTHLY BASED ON \$0 DOWN OAC

THIS MONTHS CLEARANCE SALE - \$500 OFF
 ONLY THIS MONTH - NO EXCEPTIONS - ALL COLORS TO CHOOSE FROM - OUR PRICE FOR THE QUALITY WONT BE BEAT !!!!

\$6996 \$152 MONTHLY \$0 DOWN O.A.C. (Reg \$7500)

2017 ATLAS 8 X 20' ENCLOSED HAULER

- SCREWLESS EXTERIOR PKG
- .40 EXTERIOR METAL UPGRADE FROM .30
- DIAMOND PLATED TRIM ALL AROUND TRAILER
- REAR RAMP DOOR WITH SPRING ASSIST 4000LB RATED
- 16" OC ROOF, WALLS AND FLOOR NOT 24" LIKE OTHERS USE
- RADIAL TIRES ON SILVER POWDERCOATED RIMS
- STAINLESS STEEL DOOR HOLD BACKS WITH RV FLUSH LOCK DOOR



CS2510



Kioti.com



SALE

All CK10 Models

Up to **\$3,500*** REBATE

Plus **\$500*** Customer Appreciation BONUS

— **OR** —

All KIOTI® Tractor Models

0% FINANCING* Plus up to

\$1,000* Customer Appreciation BONUS

See your local dealer or visit Kioti.com

*Offer ends 09/30/2016. Offers valid only at participating dealers. Pricing, payments and models may vary by dealer. Offer based on the purchase of eligible new equipment defined in promotional program. Some restrictions apply. Financing subject to credit approval. Prior purchases are not eligible. Offer cannot be combined with any other offer or low rate financing. Offers subject to change or cancellation without prior notice. See your dealer for full details. © 2016 Kioti Tractor Company a Division of Daedong-USA, Inc.

Beards Farm Supply Coldwater
705-325-3133

Can-Am Tractor Ltd. - Kucera Group Chatham,
519-351-4300

Blue West Equipment Courtland,
519-688-0909

Maxwell Farm Service, Maxwell,
519-922-2108

Bromley Farm Supply Ltd Douglas,
613-649-2457

McGavin Farm Equipment Walton,
519-887-6365

Coleman Equipment Inc New Dundee,
519-696-2213

R. E. Egger Truck & Machine Dunnville,
905-774-1060

Doug's Small Engines Castleton,
905-349-3027

Regional Tractor Sales Ltd. Freerton, ON
905-659-1094

Kerby Independent Tractor Service Stirling,
613-395-2176

Tractorland Inc Gormley,
905-726-2283

Kucera Farm Supply Ltd. Alvinston,
519-898-2961

Trottier Farm Equipment Alexandria,
613-525-4009

MAR-LLO

Fabricating

519-335-4135 • mar-llo@mwpol.ca

BearClaw

EASYVEY

Hay Handler

THE LATEST IN BALE SHREDDING

The all-new BearClaw Bale Processor is a bale shredder and blower unlike other bale processors. One of the BearClaw's most note-worthy features is it's absence of knives. No more sharpening knives when you should be in your barn bedding your cows. The BearClaw utilizes a nifty hook and screen setup to provide a long lasting shredding system.

BearClaw
BALE PROCESSOR



Hay Handler

You already know how weather-dependent making premium hay can be. It's the Hay Handler's job to work on your side, making the most of the haying windows the weather permits you. With it, you can merge invert, fluff or windrow your cut swaths.

But what sets the Hay Handler apart is the ease with which it handles hay pickup. With it, you can pick up a 10' wide swath of hay that has been laid out by your discbine and reduce it's drying time. With the hay handler, you can mow in the morning and do haylage in the evening.



DON'T BE DISAPPOINTED... PRE-ORDER YOUR CONVEYOR EARLY!



Seed Transport Tube Conveyor

Gently handles fragile soybeans, peas, seeds and other delicate crops

- Model 8"/26' & 8"/31' are standard sizes
- New product line, models 10"/31' & 10"/41'
- Hopper height adjustable to fit gravity wagons or tote bags
- 10" wide crescent top belting runs inside 8" tube
- Conveys materials up to a 30° Incline
- 3 stage telescopic down-spout adds to your filling convenience
- Hydraulic or electric powered
- Other sizes made to order



OPTIONS AVAILABLE - ELECTRIC DRIVE, WINCH WITH OPTIONAL BRAKE, 15" TIRES

SMALL START. BIG FINISH.



Marcrest
Manufacturing Inc.

Ultimate Small Bale Packaging System

1-519-887-9910

www.marcrestmfg.com

Small square bales are one of the highest demanded form of bales used across North America. Unfortunately, they are also the most expensive to produce. Until now. The Bale Baron by Marcrest Manufacturing takes regular 14 and 16 inch bales and packages them into time saving bundles of ease. Our Bale Packs are designed to stack efficiently into van trailers, are tightly bound using regular baling twine and are easily handled by loaders and forklifts.

EECI14536-03

Much more than a mower.

0.0%
APR
FINANCING
for 60 months



MASSEY FERGUSON

THE GC1700 SERIES from Massey Ferguson. These new multi-tasking machines are the strongest performing sub-compact tractors you can own. Loaded with features, muscle and incredible maneuverability, right now, they also come with this outstanding money-saving offer. Just another way we're helping you farm your world more cost-effectively than ever. See us soon or visit masseyferguson.us.

Shantz

FARM EQUIP. LTD.
ALMA, ONT.
Est. 1988

Tel: 519-638-3317 | Fax: 519-638-3319

R.R. #1 Alma, ON N0B 1A0

MASSEY FERGUSON is a worldwide brand of AGCO. © 2013 AGCO Corporation 4205 River Green Parkway, Duluth, GA 30096 (877) 525-4384.
*Available on select models. Contact your participating dealer for more details. Programs are subject to change without notice. Offer ends soon.

www.shantzfarmequip.com | sales@shantzfarmequipment.com

Olympus Floating Fountains



Made in Ontario-----save Big on exchange rate!!

PROFESSIONAL SLUDGE REDUCTION PELLETS

“Sludge reduction pellets offer the customer control over organic material in their ponds.”

See full details on our new website for this all our products!



TRUE BLUE WATER DYE

\$130.00

Six Packets per box
Shipping & Taxes included!

SPRING REPAIR & TUNE-UP SERVICES

We sell & repair Koender Windmills, aeration systems, and troubleshoot existing pond problems.



ELECTRIC AERATION SYSTEMS
for ponds, lakes and waste water

Algae Controlling Bacteria Packets, Weed Cutters and Nets

POND CONSULTANTS & TECHNICAL SUPPORT

KNOW YOUR POND & HOW TO MANAGE IT

Let the experience of hundreds of ponds a year help you. We will explain how to reduce odor and algae, aquatic weeds and maintenance all year round. We have the test kits, meters, and resources to handle any pond problem.

With hundreds of ponds a year experience.



www.pondperfections.com

1-866-367-5932

Distributors in:
Orangeville, Erin, Port Perry, Niagara,
London, Mildmay

GREAT DEALS AT **BELORE TRAILERS** Mt. Elgin, Ontario



Aluminum Bumper Pull

6'7" x 16 x 6'6" tall
 6'7" x 12 x 6'6" tall
 7' tall option



Corn Pro Steel Stock Trailers

6'8" x 12'
 6'8" x 14'
 6'8" x 16'



Aluminum Goosenecks

7' x 16 x 6'6" • 7' x 20 x 6'6"
 7' x 24 x 6'6" tall
 Custom Stock Trailer Available

BELORE TRAILER SALES Dealer For



Safe. Secure. Smart.



20, 25 & 30 TON EQUIPMENT TRAILERS

Air Brakes, Large Selection Available

1-877-247-7227 | www.beloretrailers.ca | info@beloretrailers.ca



Building Excellence.

Designed by our engineers for more than 50 years.



DURABLE. RELIABLE. SUSTAINABLE.

A Division of Harnois Industries Inc.
megadomebuildings.com
 1 888 427 6647



Vehicle & Equipment Storage Buildings with Extraordinary Clearance.



Why choose a building from Britespan?

Britespan offers the widest product line in the fabric building industry, with engineered structures from 24' to 200' wide to ANY length. We provide building solutions for any need, any size, and any height requirement. We design, manufacture and construct your building. Our people are experts in your industry, offering complete project management from concept to completion.

Engineering. Customization. Quality.

Learn how Britespan is leading the fabric building industry.

BRITESPAN[™] **1.800.407.5846**
BUILDING SYSTEMS INC **www.britespanbuildings.com**

STOCKMAN'S CHOICE

PORTABLE HANDLING SYSTEM

Handling cattle has never been so easy.



8 ft crowding tub/rolling door exit on and off wheel quickly and easily. Each pc available separately.



SEED TOTE

- Weather proof lid
- Long or short spout
- 4 way fork pockets
- Holds 3000 lbs or 1 seed tote bag

Use for seed or feed, premix or mineral. Available in Red or Green



LC-9

- 10 ft long ramp
- Steel checker plated floor
- Adjustable 10 in to 42 in
- 3pt hitch portable

ROUND CALVING PEN

with self locking headgate



D90B

- 88" x 32" inside dimensions
- Both side panels open
- Access door to neck area
- Width adjustable
- Weight: 960 lbs



PAX HEAVY-DUTY PARALLEL AXIS SQUEEZE CHUTE

- 8' long x 32" wide inside x 85" overall height
- Parallel axis action squeezes side
- Full sides open
- Fold down branding window
- Hinged access doors front and back
- Vertical sliding rear door
- Weight: 1860 lbs



E.S. MARTIN WELDING Linwood, Ontario

phone: 519-698-2283 email: sales@cattlemaster.ca www.stockmanschoice.ca



View 1000s of equipment listings at:
www.Farms.com/UsedFarmEquipment

Farms.comTM
BUYER'S GUIDE

VICTORIAN SERIES ROOFING

www.victorianseries.com

Tile Appearance Metal Roof



- Full length sheet, considerable less waste and less joints to leak.
- Most common residential colours with textured no glare finish in stock.

Standing Seam Metal Roof



Enjoy benefits of a portable rollformer

- Considerable less waste, roll out what and when you need it.
- No loading, unloading, transport of finished product damage.
- No need to order extra product to be sure to have enough to do the job.
- Cross cut angle saw for various angles on hips and valleys etc.
- 16" Coverage with no external screws.
- We will roll it off for do it your self or professional contractors.
- No shipping and packaging and waste to dispose.

Matching trims and accessories made in house. Manufactured in central Ontario using Canadian coil stock. 40 year warranty on paint, Lifetime warranty on steel. Large network of contractors to cover Ontario. Feel free to call for competitive rates today.



LINWOOD INDUSTRIAL CORP

153070 Southgate Side Road 15, Proton Station ON
1-519-923-9995 • orders@linwoodcorp.com



DELAWARE PUMP & PARTS LIMITED

Since 1981

11157 Longwoods Rd., Delaware, ON N0L 1E0
 dpp@delawarepumps.ca | Fax: 1.800.531.0731



HOT WATER WASHER
 3500 PSI., 3.8 GPM.
 13 H.P. HONDA,
 INTERPUMP/ FUEL OIL.
 HOSE REEL IS OPTIONAL
SAVE TIME & MONEY!



COME SEE US AT CANADA'S OUTDOOR FARM SHOW SEPT 13, 14 & 15

TRANSFER PUMPS SIZES 1-4"

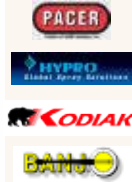

ALL TRANSFER PUMPS ARE ON SALE

SPIRAL BRUSH LAWN SWEEPERS

- 42" & 50" width
- 18 & 26 cu. ft capacity hopper
- 2 year warranty
- No slip brush height adjustment
- steel ball bearings on brush axle



KODIAK KC4350GHD PRESSURE WASHER

- 3500 PSI
- 3.8 GPM
- 13hp industrial grade Honda GX
- 4 colour quick connect tips
- 50ft of wire braided hose



PENTAIR HYPRO CENTRIFUGAL PUMPS are designed for agricultural and industrial spraying and transfer of a variety of fluids: water, insecticides, herbicides, wettable powders, emulsives, liquid fertilizers, etc.



YOUR ONE STOP SHOP FOR FIELD SPRAYING, PRESSURE WASHERS & LAWN & GARDEN PRODUCTS

EASY-KLEEN PRESSURE SYSTEMS LTD.

MANUFACTURER OF HIGH PRESSURE CLEANING EQUIPMENT

BUILT TO MAKE YOUR JOB EASY EVERYDAY

Over 300 Models Available

Proudly Canadian Made CALL US FIRST!!!



1-800-315-5533

#1 in CANADA

Email: sales@easyklean.com Visit: www.easyklean.com



Commercial 12v Oil Fired
 14 HP Kohler Engine
 3.5 GPM @ 4000 PSI
\$4495.00



Commercial Oil Fired
 7.5 HP Electric Motor
 3.5 GPM @ 3000 PSI
\$4495.00



Pickup Truck Skid
 4 GPM @ 3500 PSI
 225g Tank
\$8645.00



Industrial Oil, NG, LP Fired
 7.5 HP Electric Motor
 4 GPM @ 3000 PSI
 Oil Fired NG & LP Fired
\$7795.00 \$7795.00

Built With The Highest Quality Components In The World



OVER 400 TRAILERS ON SITE

TRAILERS PLUS

THE TRAILER SPECIALISTS

NOW IN OUR 30TH YEAR SINCE 1986

www.trailersplus.net



Corn Pro

CORN PRO LIVESTOCK TRAILERS
Bumper Pull & Gooseneck From 14'-24'
length. Call For Your Best Price.



FRONTIER STARLIGHT
All Aluminum 2 Horse Straight, Step Up
\$12,900



EBY

7x20 EBY ALUMINUM LIVESTOCK TRAILER
Centre Gate w/Slider, 7K Axles. 16'-26'
In Stock As Well As 16' Bumper Pulls.



HUSTLER 0-TURN LAWN MOWERS
Over 30 Commercial and Residential Units
in Stock Pre-Season Special

IN STOCK



20 & 25 TON EQUIPMENT TRAILERS
AIR BRAKES
Call For Specs. Available With Air Ramps



LANDSCAPE TRAILER with Landscaper
Package, 4' Ramps, Trimmer Racks, Tool Rack,
Gas Can Holders, Easy Lift Gate, Jack, 8-18' Long.



CARGO TRAILERS
CAR HAULERS
GN CARGOS



DUMP TRAILERS
3 1/2 Ton From \$4,795
5, 6 & 7 Ton In Stock



**7, 10 & 12 ton 25' Gooseneck and
Pintle Flatbeds**
in Stock 7 ton with Beaver Tail & Ramps
\$8,995

UTILITY - HORSE & LIVESTOCK - CARGO - DUMP - FLATBED - CAR HAULER - HITCHES - SNOWPLOWS & SANDERS

SALES - SERVICE - PARTS - ASK ABOUT OUR FINANCE OPTIONS!!

1.888-758-6926

OUR PRICES ARE ALWAYS SALE PRICES!

Hwy. 7 East of Peterborough • www.trailersplus.net • M-F 8-5, Sat 9-12

FOR ALL YOUR BULK STORAGE NEEDS

Taking Orders for Fall Delivery

SMITH STEEL
& FABRICATION

- Easy setup with no outside contractor required
- Quality products tailored to your specifications
- Smooth wall construction for total clean out
- Side Draw Hopper Available
- Custom Fabrication



Call Brenda - 519-356-2802 or blong@smithsteel.ca



www.smithsteel.ca

Contact Smith Steel & Fabrication For Your Customized Design and Bulk Storage

TOUGH ON WINTER, EASY ON YOU



4 great reasons to choose a HeatMaster^{SS} high efficiency wood boiler

- 1 **Built to Last** - Titanium enhanced, corrosion resistant 409 stainless steel boiler with an industry best warranty
- 2 **Easy to Use** - Many convenient features and very simple to clean
- 3 **Eliminate Your Heating Bill** - Oil is unpredictable, take back control of your budget
- 4 **Support** - Our dealer network will help with all your wood heating needs

LEASING AVAILABLE

ISO 9001 Certified



Highway 511 Heating Solutions

Call Today! 1-800-317-5114

hwy511heatingsolutions.com

ANS DOORS INC.

PREHUNG DOORS & DOOR LITES

Dealer Enquirers Welcome • Check out our prices



ALUMINUM SILLS



COMPOSITE SILLS

Specifically designed no rot doors excellent for use in high moisture Chicken, Pork and Dairy operations.

PREHUNG AG DOORS FEATURES & BENEFITS

AG-DOORS

- fibreglass doors • perfect for cleaning won't rot or rust.

VINYL PVC JAMBS

- no need for cladding

VINYL PVC BRICK MOULD

- comes with siding return and nail fin
- white, green and brown in stock, any colour available
- also solid brick mould available for brick structures

SILLS

- Composite Silks • rot and rust resistance • aluminum silks

STAINLESS STEEL HINGES

STANDARD PASSAGE SETS AVAILABLE

BENEFITS

- Install the door and ready for siding
- no need for trimming
- saving time and money on a better structure



6522 Yatton Sideroad, Wallenstein, ON | 519.669.8509 | sales@ansdoors.com

CAPTURE YOURS TODAY

INTRODUCING THE NEW HUSTLER FLIP UP DECK ZERO TURN MOWER

- ▶ Deck raises and lowers at the push of a button - easy cleaning and maintenance
- ▶ Push button deck height adjustment - 1.5" to 4.5"
- ▶ Smart Choke™ technology - turn the key and go
- ▶ Heavy duty fabricated steel decks
- ▶ Fabricated heavy duty steel frame
- ▶ Patented automatic park brake system - built into levers
- ▶ 20" drive tires
- ▶ 3 gallon fuel capacity
- ▶ 7 mph

LIMITED WARRANTY
3 YEAR | 300 HOUR

See your local Hustler dealer for complete warranty details

PRICING FROM
\$6789



CANADIAN EQUIPMENT OUTFITTERS
 Barrie - 1-866-436-3471

LANDMAN ENTERPRISES
 Chesley - 519-363-2663

REIS EQUIPMENT CENTER
 St. Isidore - 613-527-1501
 Carp - 613-836-3033
 Winchester - 613-774-2273

WEBSTER FARM SUPPLY
 Thamesville - 519-692-3899

COLEMAN EQUIPMENT
 New Dundee - 519-696-2213

AGRI CON
 Belmont - 519-644-1000

KW OUTDOOR POWER SALES LTD
 Perth - 613-326-0844

OUTDOOR SUPPLIES & EQUIPMENT
 Hamilton - 905-578-2411

NATIONAL SMALL ENGINES
 Kingston - 613-384-0061

YORK REGION EQUIPMENT CENTRE
 Keswick - 905-478-1553
 Markham - 905-604-1797

SOLO SMALL MOTORS LIMITED
 Richmond Hill - 905-773-4012

KINGDEM TRAILERS
 Flamborough - 905-627-0100

SOS SMALL ENGINES
 Lambton Shores - 519-786-4045

TURFLINE SMALL ENGINE REPAIRS
 Mount Forest - 519-323-3571

DELTA POWER EQUIPMENT
 Mitchell - 519-348-8467
 St. Mary's - 519-349-2180
 Tavistock - 519-655-2441
 St. Thomas - 519-631-5280

TRAILERS PLUS
 Peterborough - 705-745-5732

FRONTIER SALES & SERVICE
 Elmira - 519-669-8709

BOBCAT OF HAMILTON LTD
 Hamilton - 905-524-3165

HUB INTERNATIONAL
 Lindsay - 705-324-6136
 Port Perry - 905-982-1500

FARMGATE GARDENS
 Foxboro - 613-967-1581

BASE EQUIPMENT
 Lucknow - 519-529-7993

NOELVILLE RENTAL
 Noelville - 705-898-3201

BELORE TRAILERS
 Mount Elgin - 519-485-5358

BROMLEY FARM SUPPLY
 Douglas - 613-649-2457

W. E. ENTERPRISES
 Mississauga 905-629-1424

J & S PERFORMANCE

Niagara on the Lake - 905-468-9735

EVERNEW
 St. Joachim - 519-728-0047

The Greenest Outdoor Wood And Corn Furnaces



Summer Rebate with savings up to \$500



CLASSIC
Outdoor Wood Furnace



MAXIM
M250



CLASSIC
EDGE
Outdoor Wood Furnace

ASK US ABOUT THE NEW EDGE

Contact Your Local Dealers

Wood Heat Solutions - Frankford - 613-398-1611 | Cheshers Outdoor Store - Bancroft - 613-332-1613
Pumps Plus Ltd. - Elmira - 519-669-5004 | Bernard Enterprises - Brussels - 519-887-6405



centralboiler.com

www.cheshers.ca



THE MODERN BUFFERED ACID



PROUDLY MADE IN CANADA



Make Serious Hay, Call Today
519-393-5770 | 1-800-965-9127
Canada Wide Dealer Network

www.juicehay.ca



PRODUCT | APPLICATORS | TECHNICAL SUPPORT

Creating Cozier, Drier, Healthier Concrete Floors!



**INSTA-
PANELS®**

Foam Board



Find an **Insta-Panels®**
Dealer Near You!

- **INSULATING UNDER CONCRETE SLABS INCREASES ENERGY SAVINGS**
- **HIGH R-VALUE FOR MINIMAL THICKNESS - R11**
- **EASY AND EFFICIENT TO INSTALL**
- **BEST VALUE ON THE MARKET**
- **ECO-FRIENDLY**
- **MOISTURE RESISTANT**
- **CCMC APPROVED**

Barclay Dick & Son **613-432-0425**
Famers Supply
Douglas

Home Hardware **519-849-2219**
Building Centre
Watford

L.P. Wood Heating **1-866-347-3269**
Belleville

Mar-Span **519-638-2420**
Drayton

Mike Soenens **705-855-0452**
Chelmsford

Rob Noordergraaf **705-627-8977**
Stayner

Vanderlaan **613-475-3684**
Building Products
Brighton

1-800-668-0311
www.instapanel.ca



BulkTech advantage



WELDED STEEL STORAGE TANKS

POLY-STACKER STORAGE TANKS



519-625-1550 • www.bulktech.ca • email: office@bulktech.ca

On Farm Service that you can depend on.



TRELLEBORG FIRESTONE
MICHELIN BKT GALAXY

USED OR NEW T RAIL
SNAP-ON DUALS

USED TIRES

NEW OR USED RIMS



OK TIRETM
Honestly driven.

8360 Concession 8, Moorefield - 519.638.3413
1-800-265-6980 • www.oktire.com

POND & LAKE OWNERS

Add Aeration & Display to Your Pond

10 % OFF Kasco Fountains

Sale Valid until August 31, 2016 Valid at Elmira Location Only

Visit our Website for a Complete Line
of Products, Solutions & Information
& Purchase Products Online 24/7



Pond & Lagoon Aeration · Fountains · Windmills · Water Dye
Weed Rakes & Cutters · Pond Liner · UV Lights · Filtration
Bacta-Pur Beneficial Bacteria · Barley Straw & Pellets · Plumbing
Waterfall Pumps · Water Test Kits · Fish Feeders · Koi Feed

Licensed Aquatic Weed Specialists, Freshwater &
Marine Biologist and Fisheries & Wildlife Technician on Staff
Serving Pond & Lake Owner since 1989



FISH FARM SUPPLY CO.

116 Bonnie Cres, Elmira, On Toll Free: (877) 669-1096

www.FishFarmSupply.ca Info@FishFarmSupply.ca

Hours: Mon - Fri: 8 - 5 pm, Open Late Wed to 7 pm, Sat: 9 - 2 pm

also Find these Products at These Locations:

Quality Pond Aeration, Grassie 905-945-5856

Shackelton Auctions Inc.

Booking fall auctions now. We do all kinds of Auctions
- Equipment, Estate, Collectibles, Farm... Your place or ours.



www.shackeltonauctions.com | 519-765-4450

EM ELDALE
MACHINE & TOOL LTD.

**Production and
Custom Machining**

Manufacturers of Hub & Spindle Assemblies

3 Industrial Drive, Elmira, Ontario N3B 2S1

Phone: 519.669.5195

Toll Free: 1.877.669.5195

Fax: 1.800.572.6796

www.eldalemachine.com

4, 5, 6, 8, 10 & 12 bolt hubs with load ratings from
1,000 to 35,000 lbs., in implement and automotive bolt
pattern... matching spindles for 1-1/4" to 6" diameter oil
bath option available for large 10 & 12 bolt hubs!



ISO
9001 Registered

Martin
DRAINAGE

A FAMILY TRADITION FOR OVER 95 YEARS
QUALITY DRAINAGE SYSTEMS

1-877-669-1440 | www.martindrainage.com

- **GPS TECHNOLOGY** for design & installation
- Qualified & experienced team members
- Timely job completion
- Drains leveled (saves you time)



NOW BOOKING INTO 2017. CALL US NOW FOR BEST SERVICE DATES

CUT YOUR COSTS - GROW YOUR FUTURE

Celebrating our first anniversary at our new Arthur location. Looking forward
to another great year of continually improving our service for our customers in
2016... and beyond! Call today or visit us for all your drainage needs.



8172 Line 2 Wellington N, Arthur, Ontario

JAD-VENT Distributors LTD.

1-800-265-2244

www.jadvent.ca

- Available with or without heat
- Large drink area
- Easy to clean
- Operates for a fraction of the cost of heating concrete waterers

10
YEAR
LIMITED WARRANTY



Proudly Distributing....
Ritchie

**THE ONLY LIVESTOCK WATERER ON THE
... MARKET WITH A 10 YEAR WARRANTY**

**THE BEST SELLING / PERFORMING
AGRI "NO ROT DOOR" ON THE MARKET**

**STANDARD SIZES AVAILABLE IN-STOCK
FOR PICK UP OR IMMEDIATE DELIVERY**



NEW!!

Now offering custom doors in a wide choice of panel styles for an enhanced appearance. Ideal for homes, equestrian facilities, cottages, etc.!!

Preframed no rot door is an insulated interior or exterior door made of 100% Cellular Vinyl PVC engineered to resist extreme weather conditions. It cuts like wood – nails better than wood, won't split or crack. Strong, durable and termite proof. Moisture resistant with no sanding or prep work necessary.

Low maintenance, factory finished and with door lock prep.

Left or right hand inswing or outswing with stainless steel hinges. 9 lite window, clear glass window, or solid slab.

Standard or handicap sill available.



DAVON SALES INC.

DAVON SALES INC.

50 Lansdowne Ave., Woodstock, Ontario, N4T 1S3

Office: 519-537-2375 Fax: 519-537-7991 Email: info@davonsales.com

1-800-561-1706

Full inventory of new/used containers also available.
www.containeraccess.com



EASY ACCESS STORAGE CO.
SAFE AND EASY STORAGE PROVIDERS

CALL US TOLL FREE:
1-866-676-6686
Less | Rent | Safe
MasterCard Visa



-28°C/+28°C

REFRIGERATED COOLER/FREEZER

- SAVE on Refrigerated Storage with Temperature Control Food Grade Containers
 - Reliable Cooling/Freezing capability variable temperature output range from -28°C/+28°C
 - 8'w x 20'L and 8'w x 40'L -- Insulated polyurethane foam in place R-22 Insulation, Food grade Stainless Interior, Electric or Diesel Power, Stand Alone Unit
 - Facilitating Safe and Easy Access to Inventory via ground level access.
- Keep products chilled or frozen
 - No assembly required
 - Walk-in or Forklift driveable
 - Simple power connection
 - Avoid building Costs
 - No refrigerated contractor required
 - Use as temp. or permanent storage
 - Ideal for all perishable inventory

Call us toll free: 1-866-676-6686



4200 & 5500
Portable Unit



Custom Made Feed Carts



9500 Portable Unit



VB250T TMR
Trailer Mixer

www.vertablendmfg.com
519-698-2338



3965 Lawson Line RR#3
Wallenstein, Ontario



Available in 155, 250 and 350 cu. ft.
Single Screw Stationary Unit



VB55 Tumble mixer



Platform Scale

Dealer Inquiries welcome • Used units also available

7635 Hwy 21, Allenford, ON | Phone: 519.934.2193 | Fax: 519.934.2361

Elmer's Flying Supply Inc.

Home of the New
SUPER-EDGE™



**SUPER-EDGE™ FLIGHTING
UP TO 50% THICKER**

Stainless Steel Flighting in Stock

Short & Long pitch, cupped,
sectional, ribbon & reinforced
flighting 2" - 18".

**- BUILD TO SPEC
- LARGEST STOCK IN ONTARIO**

COMBINE OWNERS

WE HAVE

- Horizontal auger • Vertical unload augers
- Clean grain augers • Corn head augers



TUBING

- 3 1/2" to 14" Galvanized
- 4" to 16" Black tubes
- G.T. dryers & combine tubes
- U Trough & Accessories 6" & up
- Dodge gear reducer



"Full Tilt Cupped Flight"

**NOW AVAILABLE - AUGER BALANCING
COMPUTERIZED DYNAMICALLY & STATIC**

**CUPPED FLIGHTING EASY
ON SOYS & GRAINS**

Website: www.elmersflying.com | Email: info@elmersflying.com



A Must See Stove!!

The "ULTIMIZER"

The reinforced 2 1/2 inch thick refractory cement surrounding the fire provides:

- A hotter environment for more complete combustion.
- A cleaner, more efficient burn.
- Reduced moisture, creosote and corrosion.
- Lower emissions without the EPA pricetag.



*The Original Efficient Green One
Since 1973
...is now a sectional stove!*

Customer Testimony

We decided to purchase the Portage and Main Furnace. The Head office has been great to deal with and we got the new stove in our yard when we really needed it. We got it hooked up and have been more than pleased. We can say the the BL3444 is comparable in the wood consumption to our previous gasification stove. The blower under the fire box is great and cleaning the unit is a breeze. This unit is very well designed and built. The Portage and Main furnace, BL3444, is our third boiler and we finally got it right!

Thank you to Brain Martin and his team.
Jim and Robin McRae - Vankleek Hill, Ontario

I am happy to have made this purchase on the Ultimizer BL28-45 outdoor wood furnace. It is very efficient and easy to maintain. This furnace is of great quality. I would highly recommend this product.
Terry Staples Grand Lake, NS

DEALERS LOCATED ACROSS ONTARIO - Call us to find a Dealer near you.



Industry's Best Warranty

1-800-561-0700

www.portageandmainboilers.com



PEX-FLEX

Dual PEX-Flex is a pre-insulated pipe complete with bonded polyurethane foam insulation and smooth polyethylene jacket. It is ideally suited for hydronic heating applications including outdoor wood furnaces. Supplied in coils, this seamless 2-in-1" (supply & return bundled together) pipe system is economical, simple to install and highly effective even in harsh soil conditions.

- **A Whole Other Layer – "SMART MEMBRANE"**
This diffusion barrier eliminates aging in the foam
- **Best Insulation Material on the Market**
Closed Cell, Eco-Friendly Polyurethane foam
- **Increased Flow Capacity**
Full 1" ID carrier pipes = more BTU's delivered
- **World's Largest Manufacturer**
Over 40 years' Experience Insulating Pipes



URECON
PRE-INSULATED PIPE

LOGSTOR

1-866-PEX-COIL
(739-2645)

www.pexflex.net

NEW SKIDS ON THE BLOCK

R SERIES SKID LOADERS

R 135

Lift Height 109.6" (2784 mm)
Rated Capacity 1,350 lbs. (612 kg)

INTRODUCING!

R 150

Lift Height 119.6" (3032 mm)
Rated Capacity 1,500 lbs. (680 kg)

R 165

Lift Height 119" (3023 mm)
Rated Capacity 1,650 lbs. (748 kg)

Deboer's Farm Equipment Ltd.
ELORA, 519-846-5388

Advantage Farm Equip. Ltd
ESSEX, 866-713-6656

Advantage Farm Equip. Ltd
INWOOD, 519-844-2871

Callaghan Farm Supply
LINDSAY, 705-324-8686

Advantage Farm Equip. Ltd
WYOMING, 519-845-3346

THE NEW SKIDS ON THE BLOCK: GEHL R SERIES MID-SIZE SKID LOADERS

Three all-new additions to the R Series Skid Loader line combine the reliability and features the industry has come to expect from Gehl. These skid loaders feature an all-new operator station with an integrated digital display, new load arm design with increased visibility, Tier IV engines and several serviceability enhancements.

Find us on

GEHL

SPLITS LOGS BOTH WAYS

Self contained, 3-point-hitch or skid steer mount, all Split-Fire log splitters feature a unique 2-way splitting action from the knife that splits wood in both the forward and reverse stroke, doubling productivity and saving time!

These safe, compact 2-way log splitters prevent dangerous wood fly-outs and can turn 20 to 48 inch diameter blocks into wood piles faster than comparable single stroke machines with less effort.

Quality Built For High Performance



www.split-fire.com
T: 877.548.3473
P: 519.468.3647

SPLIT-FIRE

INDUSTRY LEADING 3 YEAR WARRANTY

BUILT BY CANADIANS, FOR CANADIANS



SIMPLY THE BEST

**TRAILER FOR TRAILER
WE BEAT EVERY PRICE
GUARANTEED!
CALL OR COME SEE FOR YOURSELF**

OVER 800 TRAILERS IN STOCK

CANADA'S #1 DUMP TRAILERS



5 TON

SCISSOR LIFT TUBE FRAME DUMPERS

- 3 1/2 TONfrom \$3,995
- 5 TONfrom \$4,595
- 6 TONfrom \$5,495
- 7 TONfrom \$5,995

FRONT MOUNT STRUCTURAL CHANNEL FRAME

- 5 TONfrom \$5,595
- 6 TONfrom \$6,295
- 7 TONfrom \$6,695
- 10 TONfrom \$8,295



7 TON



SINGLE AXLE

- 2K EPOXY PRIMER/ TOP COAT
- 3500 LB AXLE
- SEALED BEAM LIGHTS
- REMOVABLE RAMP
- EZ LUBE HUBS
- 16" SOLID-STEEL SIDES W/TIE DOWNS
- HD JACK
- STEEL FENDERS

	PAINTED
4' x 8'	FROM \$1695
5' x 8'	FROM \$1795
5' x 10'	FROM \$1895
5' x 15' (ATV)	FROM \$1995
6' x 10'	FROM \$1995
6' x 12'	FROM \$2095



DECKOVER FLOAT

- 2K EPOXY PRIMER/ TOP COAT
- 21,000 LB GVWR
- 102" X 16" X 4" BEAVERTAIL
- ELECTRIC BRAKES
- 10" CHANNEL STEEL FRAME
- 16" TIRES, 8 BOLT
- SEALED BEAM LIGHTS
- HD SLIDING/FOLDING RAMPS
- STAKE POCKETS & RUB RAIL
- AVAILABLE IN GOOSENECK & FIFTH WHEEL

SINGLE WHEEL	TANDEM DUALS
10 TON FROM \$7995	10 TON FROM \$13,636
7 TON FROM \$6995	12 TON FROM \$16,753
5 TON FROM \$5595	15 TON FROM \$22,706



"BOBCAT" LOW BED FLOAT

- 2K EPOXY PRIMER/ TOP COAT
- 14,000 LB GVWR
- 78" X 16"
- ELECTRIC BRAKES
- 16" TIRES, 8 BOLT
- SEALED BEAM
- LIGHTS
- SLIDING/FOLDING RAMPS
- STAKE POCKETS & RUB RAIL
- CHECKER PLATE FENDERS

3 1/2 TON	FROM \$2695
5 TON	FROM \$3695
7 TON	FROM \$4195
10 TON	FROM \$5295



- 5' Widefrom \$2875
- 6' Widefrom \$3595
- 7' Widefrom \$4425
- 8.5' Widefrom \$7195



MISKA WILL NOT BE BEAT ON PRICE OR SERVICE



#1 IN CUSTOMER SATISFACTION

1.866.956.8638

Monday, Tuesday, Thursday, Friday from 8am - 5pm
Wednesday 8am-7pm & Saturday 8am-3pm

3-1056 Hwy. 6 North. Hamilton, Ont.

VISIT WWW.MISKATRAILERS.COM

- Location
- Features
- Quotes
- Map
- Parts
- Product Lines

... and Much More!

NO PAYMENTS FOR 3 MONTHS O.A.C.

NO DOWN PAYMENTS

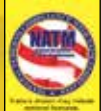

*some conditions apply

ALL IN STOCK TRAILERS READY TO FINANCE FROM \$49 A MONTH OAC



**UPGRADE YOUR MILL!
GREAT DEALS ON TRADES!**

- Reduces wood shavings cost
- Quick and easy to attach to your Steiner or Ventrac Tractor

SHAVINGS SPREADER

Imagine sitting down on the job and getting a nice even layer of shavings on your poultry barn floor while reducing your time by up to 30%!

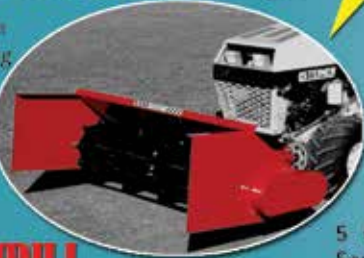

5 Compartments HammerMills. The 5 Sentry 5000, 4000 and the 3000 come standard with a base auger motor, a complete calibration kit and a design that will allow up to 3 different ingredients to by-pass the grinding chamber.

HAMMERMILL SCREENS

- Farmatic • Agrametal
- Sudenga • Mix-Mill
- Farm King • Modern Mill
- Bearty • Valmental • Mixmatic



OVER 30 YEARS OF SERVICE



www.marweld.ca **1.866.698.1151**
Marweld 2690 Manser Rd, Millbank, ON N0K 1L0



Visit our website to see a complete list of products
Marweld manufactures at www.marweld.ca

GATES	FEEDERS	ANIMAL PENNING	ANIMAL HANDLING	HORSE STALLS
 Feed Front	 Round/Square Feeders	 Feed Front	 Headgate & Chute	 Solid Divider
 WMDH Series	 2 PCS Feeder	 Tombstone Feed Front	 DST Spinner	 Diamond Divider
 D Series	 Basket Feeders	 Lambing Pens	 Working Chute & Crowding Tub	 Diamond Front
 E Series Gates				

Marweld manufactures and distributes a variety of sheep, goat and other livestock equipment, including hay feeders, creep feeders, penning and handling equipment, farm gates, corrals, and horse stalls.

The logo for Calhoun, featuring the word "CALHOUN" in white, uppercase, sans-serif font. Above the text is a white, curved line that arches over the letters, resembling a stylized roof or a swoosh. The logo is set against a red rectangular background.

AGRICULTURAL BUILDING SOLUTIONS

RETURN ON INVESTMENT. COVERED.



Keep maintenance costs low with a Calhoun fabric structure, built to stand the test of time for a fraction of the cost of traditional wood buildings. Calhoun fabric buildings are well-ventilated and filled with natural light. Whether you need a building to house your cattle, or a multi-purpose storage structure, we can help you keep your business profitable.

Let's get started.

calhounsuperstructure.com 1-800-265-3994



(519) 923-9273
 dundalkvinylwindows@gmail.com
 199100 2nd Line NE Dundalk ON



High Quality Vinyl Windows | Pre-Hung Exterior Doors | Patio Doors | Agricultural & Residential

- DOUBLE HUNG
- DOUBLE SLIDERS
- CASEMENTS
- PICTURE
- SINGLE HUNG
- SINGLE SLIDERS
- AWNINGS

L.P. WOOD HEATING SYSTEMS LTD.

Lee/Evelyn Price
 RR#1 Belleville, ON K8N 4Z1

www.outdoorwoodfurnace.ca woodheating@yahoo.com
 Call for pricing 613.969.8025 or fax 613.969.4493



MADE FOR CANADIAN WINTERS

EMPYRE

**OUTDOOR
 WOOD
 FURNACE**

**FINANCING
 AVAILABLE**

Large Quantity of Furnaces in Stock
 Used furnaces also available for sale

304 Stainless Steel
 1.866.347.3269
 Canada's Largest Dealer

250
 Stainless Steel and Mild Steel
 Heats up to 4000 sq.ft.

450
 Stainless Steel and Mild Steel
 Heats up to 8000 sq.ft.

Be the first to get news, market prices, great buys on used equipment, events and more...

JOIN THE #1 LEADING TWITTER ACCOUNT FOR ONTARIO AGRICULTURE



Follow us on
Twitter
www.twitter.com/OntAg

Farms.com™

@OntAg



CLEAN, DEPENDABLE, FUEL-EFFICIENT POWER —AND PLENTY OF IT.

Power is the key to superior tractor performance, and the M7 has plenty of power. But when a particularly tough job demands even more power, the M7 activates its Power Boost, and the engine instantly delivers more power to let you finish what you started.



The New M7 offers superior hydraulics and sophisticated control to get the job done quickly and efficiently. Kubota's V6108 engine delivers 168, 148, or 128 HP (3 models).

THE KUBOTA M7

SEE YOUR NEAREST KUBOTA DEALER

BELLEVILLE

Anderson
Equipment
613-969-6246

ERIN

Ed Stewart's
Equipment
519-833-9616

SUNDERLAND

Ross Doble Inc
705-357-3123

OWEN SOUND

Earth Power
Tractors &
Equipment
1-800-475-2693

FOREST

Delta Power
Equipment
519-786-5335

BROCKVILLE

Weagant Farm
Supplies
613-342-0668

ESSEX

Delta Power
Equipment
519-776-5238

MEAFORD

Earth Power
Tractors &
Equipment
800-265-3730

OSHAWA

Durham Kubota
Equipment
905-655-3291

WINCHESTER
Top Line Trailer
613-774-0992

LONDON

Hyde Park
Equipment
519-471-1400

LINDSAY

Callaghan Farm
Supply
705-324-8686

STAYNER

Earth Power
Tractors &
Equipment
888-428-3188

WYOMING

Advantage Farm
Equipment
519-845-3346

ELORA
DeBoer's
Equipment
519-846-5388

HENSALL
Hyde Bros.
Farm Equipment
1-800-461-6089





"SEE US AT CANADA'S OUTDOOR FARM SHOW IN SEPT."



**RUGGED AND EFFICIENT
SETTING THE STANDARD HIGHER - FROM 6 TO 34 M³**

FULLY GALVANIZED
HYDRAULIC BRAKES
OVER-SIZED BEATERS
REAR HOOD AVAILABLE

**CALL US
FOR A
DEMO**

CONTACT : AL NOORLOOS : 1 519 490-5750

LOADERS FROM 26 TO 75 HP : DEMO UNITS AVAILABLE



TIPPING TRAILERS FROM 8 TO 24 T



**- HIGH VISIBILITY
- TIGHT TURNING RADIUS
- INCREASED OPERATOR COMFORT**



E-MAIL : noorloos@slicc.net | PICHONINDUSTRIES.com

Clark's Mobile Homes

www.clarksmobilehomes.com & [.ca](http://www.clarksmobilehomes.ca)

Hwy. 124 GUELPH, ON
Monday-Friday 10-5, Saturday 12-4, Sunday Closed

519-822-3930

OVER 50 HOMES ONSITE

16x80 FAIRMONT SHOW HOME
We have sold over 2000 mobile homes
and this is the NICEST EVER!



\$80,000 PLUS TAX
DEL SET
7.8% TAX REBATE!

28x52 HOME BY FAIRMONT

- SHOW MODEL
- 3 Bedrooms
- 2 Bathrooms
- Huge Open Concept

\$75,000 PLUS TAX
DEL SET



**16x72 HOME
BY FAIRMONT**

- 2 Large Bedrooms
- 2 Bathrooms
- HUGE Living Room

\$81,000 PLUS TAX



**REBATE ON NEW
- 7.8% BACK**

2016 NEW MOBILE HOME - 4 bedroom, 2 bathroom \$63,000



OFFSHORE HOUSING

Designed for the farmer with offshore or big family housing in mind.

All Mobile Homes Are Manufactured Housing "Shop The Rest And Get The Best At Clark's"



1-866-216-4113

WWW.LRSHELTERS.CA

Hamilton: info@LRSHELTERS.ca

Ottawa: LRSHELTERS@gmail.com

Leasing Available OAC



ENGINEERED DRAWINGS INCLUDED WITH EVERY BUILDING



All RT Shelters meet a minimum snow load of 50 psf

30x80 open ends with fitted 14 mil cover \$7469 or with 24 mil cover \$8944



RT Greenhouse Kit
30x48 double poly cover & open ends from \$3998



RT Animal Housing
double white poly/roll up sides (tarp cover options available)
30x70 \$6089



30x95 \$7915



RT Horse Run-In
24x48 14 mil tarp cover & open ends from \$3930



RT Salt Bin Cover
20x30 14 mil tarp cover & back cover from \$2790



42' wide Truss Shelter.
Tarp cover 12 oz/24 mil. Call for pricing details.

RT Design Available In Widths of 30', 27', 24', 20' and 17'
Shelters can be made to any length : 24mil tarp cover upgrade is available

FERTILIZER & CROP TRANSPORT AUGER

HANDLES ALL CROPS WITH POWER & EFFICIENCY

- Sturdy removable plastic hopper
- Hydraulic top drive - 5.9 cubic inch motor
 - 3-stage telescopic down spout
 - Tapered roller bearings in hubs
 - Easy to tow

6 MODELS

CTA 6" x 21' CTA 8" x 21'

CTA 6" x 26' CTA 8" x 26'

CTA 6" x 31' CTA 8" x 31'

(CTA 6" models available
in stainless steel)

 **JG Augers**

Manufactured and Distributed by:

WEBERWAY Inc.



7425 Side Road 12 RR#1
Moorefield, Ontario
Fax: 519-638-3370

**FOR MORE INFORMATION CALL 1-866-638-2104
CONTACT US DIRECTLY - DEALER INQUIRES WELCOME**

CREEKBANK WELDING

519-846-5451

7111 NOAH ROAD, RR#1 ELMIRA, ONT

STEEL BALE RACKS

Combo bale rack - cost effective open floor design for large square and round bales. All steel adjustable & non adjustable bale racks - for round bales

BALE THROWER RACKS

Standard size 8'5" x 20' x 8' heavy mesh floor, 66" side openings, fold down front

FLAT RACKS

Available models include; mesh floor, checker plate floor, steel board floor - will not damage twine

MULTI PURPOSE WAGONS

30" wide 4 wheel steering, available in various sizes, 72" dump model available. 4.80x8 tires

MEDIUM DUTY WAGONS

2 wheel steering, 1200lb capacity. 13x5.00 - tires

ROTARY BALE CARTS

Low cost method of feeding round bales in the stable, complete with 4 wheel steering & park brake

COMPACT DUMP TRAILERS

- 2 hydraulic dump models available • 2 ton single axle • 48"x84" box size
- 3 ton tandem axle • 54"x96" box size • 2 ton wagon gear

ATV DUMP TRAILERS

Available sizes include 12 cu. ft., 20 cu ft, 25 cu ft, and 30 cu ft capacity, single axle or walking tandem axles available, hydraulic dump model also available

SLANT BAR FEEDER WAGON

Hinged hay cradle and rear fold up panel allows for easy clean out. 20' and 24' models.



GREAT FALL SAVINGS are blowing your way!



CS490-16" 50.2 cc
\$399⁹⁵
SAVE \$100



CS590-18" 59.8 cc
\$499⁹⁵
SAVE \$100

WHO'S AFRAID OF THE
BIG BAD WOLF?

5 year
Consumer
Warranty

Buy One - Get One FREE! Replacement Chain Offer:

Purchase any ECHO chain saw and a loop of replacement chain
and get a second identical size loop FREE!
(\$25 value) Offer not valid on CS310.



CS310-14"
\$279⁹⁵
SAVE \$20



FREE
with CS310
purchase

Suit up this Fall

SAFETY-FIRST

ECHO Cutter's Kit

Includes Helmet with
Visor and Ear Protection,
Gloves and
Safety Chaps

ONLY

\$99⁹⁵

**SAVE
\$32**



Available at these participating ECHO Dealers:

BRANTFORD Antlers Equipment	519-753-6433	LIMOGES Michel Blais Sales & Service	613-443-1230
BRANTFORD Town & Country Sales & Service	519-484-2901	LUCKNOW Robert's Farm Equipment	519-529-7995
CHESLEY Robert's Farm Equipment	519-363-3192	MILLBANK Zehr Sales & Mfg.	519-595-7579
CREEMORE Maple Valley Sales & Service	705-466-3138	NEW DUNDEE Coleman Equipment Inc.	519-696-2213
DELAWARE Lawn and Garden Depot	519-652-9611	ORILLIA Allen Byers Equipment	705-325-2746
DRESDEN DNR Outdoor Power Equipment	519-683-6963	RENFREW Reis Equipment	613-432-4133
ELMIRA Woolwich Rentals	519-669-0524	ROCKWOOD Connect Equipment	519-856-9512
ELORA De Boer's Farm Equipment	519-846-5388	SCOTLAND Brant Farm Supply	519-446-3925
GRIMSBY Ag & Turf Power Service	905-945-4848	STONEY CREEK Bobcat of Hamilton	905-643-3177
INGERSOLL Ken's Small Engine Repairs	519-425-4466	WALTON McGavin Farm Equipment Inc.	519-887-6365
KOMOKA Komoka Machine Ltd.	519-657-2113	WINCHESTER Dan R Equipment	613-774-1616



All prices shown are in effect from
September 1 to November 30, 2018,
and do not include applicable taxes.

www.echo.ca 



**X7
VT-DRIVE
SERIES**

Each McCormick tractor reflects the passion and dedication of those involved in its design, testing and production. The new X7 VT-Drive tractors offer the ultimate in performance, technology, operator comfort and ease of operation. Two models in the range are powered by the new BETAPOWER diesel engines with multivalve technology and common rail direct fuel injection. These engines meet Tier 4i emission regulations using advanced SCR. The X7.450 VT-Drive model features a 4-cylinder engines that generates up to 160 horsepower, while the X7.670 VT-Drive model boasts a 6-cylinder engine that delivers a massive 194 maximum horsepower to get the job done. The electronically-controlled rear hitch with draft sensing provides a maximum lift capacity of 20,500 lbs (9300 kg) and allows precise control of mounted implements. The Premiere Cab is a true high-tech control center that allows the operator to work the tractor with maximum ease and comfort. The cab features the Data Screen Manager (DSM) as standard equipment on the VT-Drive models.

B & G LOUGHLIN TRACTORS
Mountain - 613-989-3839

BLUE WEST EQUIPMENT
Courtland - 519-688-0909

HAWLEY'S GARAGE
Belleville - 613-969-5525

BEARDS FARM SUPPLY
Coldwater - 705-325-3133

G.J.'S FARM EQUIPMENT
Burgessville - 519-424-9374

MARK MCCABE TRACTOR SALES
Lindsay - 705-879-8882

PROFOTA'S FARM EQUIPMENT
Chatham - 519-354-5100

R.E. EGGER TRUCK & MACH.
Dunnville - 905-774-1060

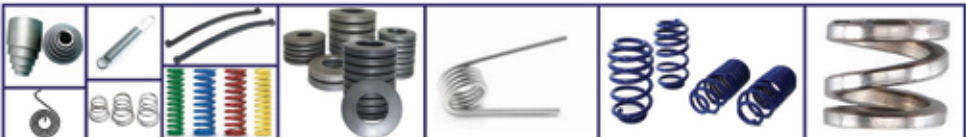

TRAKAR
PRODUCTS INC.
THE SPRING SHOP

Your One Stop Spring Shop
Has Expanded To Serve You Better

Over 20,000 Stock Spring Varieties
In Our New Warehouse!



Custom Springs
Made To Your Exact Specifications!



Warehouse Division:
14 York Road, Brantford, ON N3T 5Y6

Manufacturing Division:
225 Boida Avenue, Ayr, ON N0B 1E0

T: 519-753-8080

F: 519-753-3003

sales@trakar.com

www.trakar.com

www.baumanmfg.com



- CONVEYORS & ELEVATORS
(BELT OR CHAIN TO MOVE HAY, STRAW,
FEED, ICE, WOOD & AGGREGATE)



- CHAINS
- PTO
- DRIVE PARTS



- STABLING
- GREENHOUSE/HORTICULTURAL
- CUSTOM FABRICATION

- HAY FLUFFER
- TEDDER
- SANDERS



Original Equipment Manufacturer
519 669 4333

Farms.com™

POWERING YOUR SUCCESS!



EVERYTHING AT YOUR FINGERTIPS

Farms.com™

Find Information: www.farms.com



Find News: www.farms.com/news



Find Market Reports: www.farms.com/markets



Find Classifieds: www.farms.com/classifieds



Find Used Farm Equipment: www.farms.com/used-farm-equipment



Find Farm Videos: www.farms.com/videos



Find Yield Data: www.yielddata.farms.com



Find a Farm: www.farms.com/realstate



Find a Job: www.agcareers.com



Ontario Agriculture
The network for agriculture in Ontario, Canada

Follow us on Twitter: @ontag

CANADA TRAILERS PARTS SUPERSTORE

We have a huge selection of all your trailer parts in stock and ready to go!



We have a huge selection of brakes, drums and hubs, double eye and slipper springs, couplers, tires and wheels, jacks and all hardware you need for you trailer.

COME SEE OUR NEW LINE OF TRAILERS FROM BRAVO
Prices starting at \$2,695.00 for the 5x8 v-nose

The Scout Trailer model line,
Bravo Trailers.
A Scout trailer is work ready!



STANDARDS

- .030 thick aluminum skin
- 16" o.c. wall posts
- 3/4" plywood floor (8.5'w)
- 3/4" drymax floor (5, 6, & 7'w)
- 3/8" interior sidewalls
- protected wiring
- side door
- sidewall vents
- clear LED interior & exterior lighting
- and much more

Scout is a great value in enclosed cargo trailer design. Sizes range from 5x8 to 8.5x24TA3 with a list of options as well. If you're in the market for an economical cargo trailer, yet built to stand up to years of use, Scout is for you!

CANADA TRAILERS

www.canadatrailers.com | Contact John 519-765-1717



YOU'LL RUN OUT OF JOBS BEFORE IT RUNS OUT OF MUSCLE.

We hear it all the time. You want a tractor that has the size, comfort and simplicity of a compact, but with additional muscle to handle bigger jobs like mowing and loader work. The Massey Ferguson® 2700E Series is the perfect fit. It's ideal for large properties, hobby farms, even landscaping businesses. Solid, stable and boasting a tight turning radius, these versatile tractors will get after some of your hardest jobs around the yard or barn.

FROM MASSEY FERGUSON
A world of experience. Working with you.

www.masseyferguson.us

Massey Ferguson is a worldwide brand of AGCO.

CHECK OUT THE MASSEY FERGUSON 2700E SERIES

HAWLEY'S GARAGE BELLEVILLE

MCKEOWN MOTOR SALES SPRINGBROOK

SHANTZ FARM EQUIPMENT LTD. ALMA

WJ LAMBERT & SONS LTD BEAVERTON

ADVANTAGE FARM EQUIPMENT THAMESVILLE/WYOMING/INWOOD/ESSEX/LONDON

DURABLE DESIGNED CONSTRUCTION WITH MULTI-ADJUSTABLE SETTINGS



12287873_0513

Fully enclosed
2"x 5" tube post
NOT
a channel post.

Stalls available with or without manger divide. Stainless Steel High Flow Non-Splash Water Bowls.

Most models in stock & ready for immediate delivery!!

MADE IN CANADA



D. M. HORST & SONS LTD.

Elmira, Ontario

519-669-2520 or 519-925-4317 after hrs.

- 36", 42" & 48" Dividers
- All Product made with Galvanized Steel Only!
- Special Orders Accepted
- BSM Dealer
- Full Line of Hog Stabling



Listowel, Ontario

519-291-5035

Trailers for Estate, Contractor, Industrial, Agricultural



NEW Pin Free Door / Ramp Combo!



Easy 1-hand release w/ innovative cam-lock Spring Assisted Ramps

DWL Dumpers Available in 10', 12' and 14' 5 ton, 6 ton and 7 ton models



Roll-off Systems Trailer Mounted Bins & Decks



12', 15' and 18' Cattle Trailers

Farm & Industrial Dump Trailers



WL12ST2010



WL24 ST2030

6ET

Custom Ordered Job Site Trailers



Tel: 519-291-5035 Email: sales@weberlane.com

Listowel, Ontario N0G 1B0

www.weberlane.com



TO OUR READERS:

Our next edition of Farms.com Ag Buyer's Guide will be distributed at the beginning of September. It's going to be a great magazine, and we don't want you to miss it.

In the event of a postal service disruption, you can still get your edition of Farms.com Ag Buyer's Guide.

YOU CAN PICK UP YOUR MAGAZINE ACROSS ONTARIO AT YOUR LOCAL

- o TSC Store
- o Co-op store
- o Ag Association

ALSO AVAILABLE AT THE FOLLOWING LOCATIONS

- o Penner Farm Service
- o Stoltz Sales & Service
- o Bryan's Farm and Industrial
- o McGavin Farm Equipment
- o Minor Bros. Farm and Country
- o Husky farm Equipment

You can read a digital edition by visiting www.Farms.com/UsedFarmEquipment. Or you can visit our Ag Buyer's Guide/Farms.com offices in Guelph or London during normal business hours

Guelph Office
52 Royal Rd. Unit A
Guelph, Ontario
N1H 1G3

London Office
1615 North Routledge Park, Unit 25
London, Ontario
N6H 5N5

Farms.com
BUYER'S
AGGUIDE



EEC16315

INTRODUCING
FIREBOLT

THE ALL-NEW 2x2 SPEED LOG SPLITTER

**30%
FASTER**
VS PREVIOUS 70M40
11 SEC
FULL CYCLE

**27 TONS
SPLITTING
FORCE**
3400 PSI

**FACTORY
TUNED**
**TO RATED
PERFORMANCE**

Introducing the all new Wallenstein Firebolt, the first 2x2 speed log splitter that is both faster and stronger. Featuring 27 tons of splitting force, a Honda engine and an 11 second cycle time, the Firebolt is the high performance log splitter designed for heavy volume firewood production.

WALLENSTEIN

wallensteinequipment.com
 1-877-695-9283

CONSTRUCTION

AGRICULTURAL | RESIDENTIAL | COMMERCIAL



GLEN VALLEY

CONSTRUCTION



KEITH METZGER

a : 6516 Sideroad 17, RR#2
 Wallenstein ON NOB 2S0

c : 519.404.1084

keith@glenvalleyconstruction.com

check out our new website:
 glenvalleyconstruction.com

Choice. When you're building your home, office or barn, you want to build—well, in your style. Choice begins with planning. Long term goals. Creative ideas....and your choice of a contractor. Glen Valley is here to help you leverage the power of choice toward a completed job that is truly yours.



Phone: 519-523-9897
Email: info@grainstovesinc.com



Up to 25 year life cycle

**3 year
return on
investment**



COST TO PRODUCE 50,000 BTU'S PER HOUR WITH VARIOUS FUELS		
FUEL	COST/UNIT	COST PER DAY
CORN	\$5.00 PER BUSHEL	\$15.31
OIL	\$0.93 PER LITRE	\$30.18
WOOD	\$85.00 PER FACE CORD	\$15.51
PROPANE	\$0.45 PER LITRE	\$22.46

PRODUCT DISCRPTIONS			
PRODUCT	HEATING CAPACITY	HOPPER CAPACITY	CHIMNEY REQUIRED
GRAIN COMFORT STOVE	Up to 2000 SQ. FT.	60 LBS	NO
FURNACE	Up to 3500 SQ. FT.	200 LBS	YES

Dealers and/or Distributers wanted in Canada/USA!

FAMILY OWNED, OPERATED AND MANUFACTURING GRAIN BURNING PRODUCTS FOR 25 YEARS, WITH A GOAL TO PROVIDE CUSTOMERS WITH THE BEST ALTERNATIVE HEATING SYSTEMS AVAILABLE. SERVING CUSTOMERS ACROSS CANADA & THE UNITED STATES.



613-264-0604 office • 613-812-0457 cell
ssh@bellnet.ca
www.southshorehomes.ca

SOUTH SHORE HOMES

Canadian Manufactured Modular Homes, Cottages, Garden Suites

South Shore Homes is a 3rd generation family operated company offering best value for your money, highest quality, greater energy efficiency, and affordable custom design options since 1985.

We are familiar, knowledgeable, and willing to assist you with the challenges of placing a new home on your site including permit applications.

Whether it is your family home, cottage, farm help accommodations, or retirement/in-law suite. We encourage you to have all the facts before making one of life's largest investments.

Our unwavering commitment to excellence enables us to provide you with the ultimate in comfort, quality, and durability which will be carefully and skillfully transported right to your site.

Contact us for an appointment to view our model homes located 13kms east of Perth, just off Hwy#7.





TRANSIT TRAILER LIMITED

Locations Across Ontario & Quebec
844-440-2885

NEW



Lode King Quad Axle Grain Hopper



Lode King Grain Hoppers - All Models in Stock



Timpte Tridem Grain Hoppers - All Models in Stock



Stargate Grain Dumps

USED



(3) 2010-11-12 Lode King Grain Hopper Trains in Stock



2007 Wilson Tridem Hopper in Chatham



2007 Cobra Quad Axle Grain Dump in Chatham



2011 JD 7430 Premium MFWD, 687 hrs, 20 speed, Quad range transmission, very clean. \$139,000

TRANSIT TRAILER IS A PROUD DISTRIBUTOR FOR THESE MANUFACTURERS:





**WHERE AUGERS CAN'T GO...
BLOWRITE IS SURE TO BLOW!**

PUMP UNIT



**NOW AVAILABLE
LOBE PUMP WITH
LESS MAINTENANCE**

AIRLOCK W/ MILL MOUNT



AIRLOCK W/ HOPPER

BLOW-RITE IS THE PNEUMATIC CONVEYOR CONSTRUCTED WITH PERFORMANCE AND QUALITY TO ENSURE REDUCED MAINTENANCE AND INCREASED SATISFACTION FOR YOUR APPLICATION OF CONVEYING DRY OR HIGH MOISTURE PRODUCTS SUCH AS FEED, GRAIN, SEED ETC. WITH EASE AND RELIABILITY.

CALL YOUR LOCAL DEALER

BORNHOLM
GETHKE QUALITY LIVESTOCK SYSTEMS - 519-347-2531
STRATHOY
DORTMANS BROTHERS BARN EQUIP. - 519-247-3435

ELMIRA
NU-MATIC SYSTEMS - 519-669-5064
GRANTON
AVONBANK AG SOLUTIONS - 519-225-2507

ESTATE HARROW
www.chainharrow.net

SPECIFICALLY
DESIGNED
FOR EQUINE
GROUNDSKEEPING!



- manufactured using hard 1/2" 1045 round rod
- ideal for landscaping, turf maintenance, riding rings & anywhere a less aggressive light duty harrow is needed

BRIDGE HARROW



**THE "BRIDGE"
CHAIN HARROW**



Sizes 5 ft through 26 ft
SUPER HARD TEETH & LINKAGE.
MANUFACTURED WITH 5/8" RND
1060 HIGH CARBON STEEL
COMPLETE CARRIER SYSTEMS
AVAILABLE.

THE STRONGEST, LONGEST LASTING CHAIN
HARROW ON THE MARKET 4 GENERATIONS
MANUFACTURED IN NORTH AMERICA

**MAY-BRIDGE
HARROWS**

519-843-1959
www.maybridgeharrows.com
Belwood, Ontario



**WORKING
FAST**



**STAYING
SAFE**

Husqvarna chainsaws have always met the high demands of professional users and our latest all-round saws for land and home owners continue this tradition. They feature powerful and efficient X-Torq® engines, Air Injection™ air cleaning and Low Vib® vibration reduction so that you can work both faster and safer.



For more information visit your local Husqvarna dealer or husqvarna.ca

CONNECT WITH US ONLINE



FIND YOUR HUSQVARNA AT

Ag & Turf Power Service
104 MudStreet, Grassie (Grimsby)
905-945-4848

Allan Byers Equipment Ltd
5666 Hwy 12 South, RR#7, Orillia
705-325-2746

Battlefield Equipment Rentals
1 Coad Rd., Trenton
613-392-9278

Dougs Small Engines
1941 Country Road 22, Castleton
905-349-3027

Ed Stewart's Equipment
9410 Wellington Rd 24, Erin
519-833-9616

E & F Sauder Sales & Service Ltd
4790 Herrtott Rd., Wallenstein
519-669-2192

Eganville Country Depot
8763 Hwy 41 & 60, Eganville
613-628-2272

Hitch City
5170 Dixie Road Mississauga,
(905) 625-4664

Hitch City
102 Commerce Park Dr. Barrie
(705) 792-9204

Hitch City
1545 Warden Ave. Scarborough,
(416) 299-4960

Jean-Claude Cayer Enterprises Ltd
708 Limoges Rd., Limoges
613-443-2293

Kentvale Merchants Ltd
712 K Line Rd., Richards Landing
705-246-2002

Partner Ag Services
3694 Bruce County Road 10, Tara
1-877-349-3276

Profota's Farm Equipment Inc
24768 Centre Side Rd., Chatham
519-354-5100

Riverside Power Equipment
8368 Fairland Rd., Listowel
519-418-3126

© 2016 Husqvarna AB. All rights reserved.

Husqvarna
READY WHEN YOU ARE



www.AgCareers.com/Ontario-jobs.cfm

The leading online job board and human resource service provider for agriculture, food, natural resources and biotechnology.

FEATURED JOBS

Dairy Sales Specialist

Avonbank Ag. Solutions
Perth Counties, On

Grain Merchandizer

Wanstead Farmer's Co-operative Ltd.
Wyoming, On

Energy Assistant

Lucknow District Co-operative Inc
Lucknow, On

Sales and Marketing Manager

AgroSpray Limited
Tillsonburg, On

Regional Specialist

Agricorp
St Catherines, On

Market Development Coordinator

Grain Farmers of Ontario
Guelph, On

Safety Professional

Cargill, Inc
Guelph, On

Hub Operations Manager

Farmers Edge Inc.
London, On

Advertising/Marketing/Sales Position

RK Animal Supplies Ltd.
Moorefield, On

(Bilingual) Manager - Consumer Outreach

Litherland & Company
Mississauga, On



Start Your Search For Local Jobs Now!

TO POST A JOB

Shannon Fawns | 877.438.5729 x204 | Shannon.Fawns@AgCareers.com

HAVE
DINNER
ON US!



SOIL



MANURE



FEEDSTUFF

Call and mention
this ad for a chance
to win a \$50 gift card to
a restaurant of your choice!

Map out better yields and better profits.

Soil, manure, & feedstuff analysis for better performance & profit.

Analysis makes cents.

For more information on our Independent Lab
Services for manure, soil, feedstuff & water contact:
info@stratfordagri.ca or 1-800-323-9089

Stratford
Agri Analysis



Brush Mulching & Rock Crushing Contractors

- Trees up to 21" Diameter Mulched
- No Piles or Burning
- Rocks up to 10" crushed

MARVARA... *Consider it Done!*

519-501-6571



714 Arthur St. South, RR #2 Elmira ON

TEL: 519.664.3383 FAX: 519.664.1668

Also Available:

- Flat Racks
- 2 Ton Compact Wagons
- Tires/Rims



BEARINGS
IN ALL
KING PINS



AUTOMOTIVE
TYPE BALL
JOINTS



TRAILBLAZER
SERIES

Sizes Available
From 6-18 ton

CALL OR EMAIL FOR MORE INFO

email: sales@martinwagons.com | www.martinwagons.com

Stoneage

FARM & INDUSTRIAL EQUIPMENT

www.stoneageequipment.com • 519-393-6415



Case IH 4210, 4wd, quick attach bucket

\$19,500



Case 2090 cab heat and ac

\$11,500



Ford TW 5 new rear rubber

\$14,900



NH TC 33D with loader, 4wd, 2700hrs

\$15,900



Ford 600 3pth pto

\$4900



John Deere F925 Diesel mower

\$3500



GEHL 3925 skid steer, works great

\$13,900



Kubota F2880 4wd, diesel mower, front blade

\$5900



Massey Ferguson 210 diesel 3 pth pto

\$3900



Massey Ferguson 1030 diesel 3 pth pto

\$3900



Ford 7700 tractor cab, dual power and sensing

\$14,900



Massey Ferguson 20C industrial quick attach bucket 3pth pto

\$10,500



Holder C9700H sidewalk machine, sander with hyd dump, front blade

\$14,900



Ford 5000 tractor high arch

\$7500



Hardi tango orchard sprayer

\$7900



Massey Ferguson 10 shank chisel plow 3pth

\$2900



Int 55 3pth 11 shank plow

\$2900



Kubota B2763 front mount hyd angle blade

\$1500



Bush hog 6' HD trail brush cutter

\$2900



Himoinsa 77KVA generator, Iveco 6cyl. diesel, silent auto start etc

\$12,900



Frontier 3 pth 5' brush cutter

\$1900



Walco 3 pth tool arm ditch bank mower, 3 blade hyd angle & lift. like new

\$6900



Ford 5' finishing mower

\$1500



3 pth 3 row carousel planter

\$2500

5475 Line 26 - RR #2 St. Pauls Station • Delivery Available

WE BUY YOUR USED EQUIPMENT AND TRACTORS!

Stoneage

FARM & INDUSTRIAL EQUIPMENT

www.stoneageequipment.com • 519-393-6415



Kewanee 20' disc
\$6900



Allis Chalmers 2300 18' disc
\$3900



Case 995 tractor, loader, diesel
\$6900



Ford 18' disc
\$3900



New Idea 2 row super picker/sheller
\$3900



NH 489 haybine, good rolls
\$3500



NH 477 haybine 7' cut
\$4500



NH 514 manure spreader single beater, very good condition
\$4500



Bobcat 440B, gas, 3 buckets
\$8900



Vicon 3pth 7 row scuffler
\$2500



Turnco 275 bushel gravity wagon with hyd fert auger
\$3500



Turnco 225 bushel gravity wagon
\$1700



8' x 16' flat rack wagon
\$1200



MF 4 row scuffler
\$975



Hardi TR 500, 50' boom, chemical injector
\$3900



Ford 3pth 6' disc
\$1200



Stoll trail rotary rake hyd lift
\$2900



New Idea hay crimper
\$1100



Market 10' hyd fert auger
\$1200



Gas power hydro seeder
\$1900



Low quick attach hyd post hole auger, 2 speed
\$2900



MF Dyna balance sickle mower
\$1900



JD 1140 diesel orchard cab AC 2600 hrs 3pth pto, remotes
\$7900



Hardi TR 800, 60' hyd fold boom, chemical injector
\$7900

5475 Line 26 - RR #2 St. Pauls Station • Delivery Available

WE BUY YOUR USED EQUIPMENT AND TRACTORS!

Omni Structures *are the* Stronger Choice

FREESTANDING GREENHOUSES & UTILITY STRUCTURES

Engineered for 50 lb/sf Snowload



**FROM 20' TO 40' IN WIDTH
BY THE LENGTH YOU REQUEST**

**CALL US TODAY FOR
A FREE QUOTE.**

For all your growing and storage needs

Suppliers of Polyfilm, Polycarbonate Panels, and Polyfastening Track.



We've had you covered for over 20 years • 1.800.991.0600 • www.omnicanada.com

Landini

THE 4 SERIES is the very latest addition to the Landini tractor family. Designed to replace several heritage series tractor lines with a single, more versatile range, the 4 Series fully revolutionizes Landini's low- & medium-power segment.

SIX MODELS ranging from 64 to 107 hp, and are powered by Deutz 4-cylinder engines that meet the EPA's strict Tier 4i emissions requirements.



www.landini.ca

12X12 SHUTTLE AND POWERSHIFT

The 4 Series tractors feature a versatile, modular 12x12 transmission with four synchronized gears in three ranges

DELUXE CAB

Designed to offer best-in-class operator comfort, the cab of the 4 Series tractors has an automotive-style interior with ergonomically arranged controls providing a safe and stress-free working environment for long hours in the field

HIGH PERFORMANCE HYDRAULICS

Featuring two gear-type pumps, one feeding the steering system and the other operating all hydraulic functions, the hydraulic system in the 4 Series has the braun to handle heavy demands.

ALMONTE M&P Farm Equipment Ltd. 613-253-4957

COLDWATER Beard's Farm Supply Ltd. 705-325-3133

CHATHAM Profotas Farm Equipment 519-354-5100

DOUGLAS Bromley Farm Supply 613-649-2457

Why a chevron reel design? Because it matters.

Imagine if the tires on your pick-up had steel bars straight across the tire every five inches around. You would hop and lurch and bounce down the road and it would be incredibly rough. It might be a ride you'd rather avoid.

Yet, most reels attached to tillage tools are a straight bar design that does pretty much the same thing. They hop and lurch and bounce across the field and the soil behind them certainly shows the evidence.

Our exclusive Sunflower chevron reel design has raised sections that never lose contact with the surface. In fact, you can smoothly roll them across floor. The result is reels that pull 30% easier, eliminate vibration and conditions your soil more uniformly.



- ALMA Shantz Farm Equipment, 519-638-3317
- BEAVERTON WJ Lambert & Sons Ltd., 705-426-7374
- BELLEVILLE..... Hawley's Garage, 613-969-5525
- CACHE BAY Groulx Equipment, 705-753-3282
- GANANOQUE Dan R Equipment, 844-381-5500
- MOUNT FOREST Maple Lane Farm Service, 519-323-4289
- PLANTAGENT Dan R Equipment, 888-495-4395
- SPRINGBROOK..... McKeown Motor Sales, 613-395-3883
- WINCHESTER..... Dan R Equipment, 888-395-2831



5F15C0045T © 2015 AGCO Corporation. All rights reserved. AGCO has a corporate policy of continuous product improvement and development; therefore, specifications are subject to change without any advance notice. AGCO is not responsible for differences between the specifications or illustrations contained in this publication and the actual equipment. Equipment produced by other manufacturers is shown in photographs in this brochure for the purpose of illustration only and is not intended as an endorsement of that particular equipment or its suitability.



PLAS-TECH

Think Plastics™

**POLYCARBONATE
MULTIWALL & CORRUGATED SHEET
STOCKED IN 24' LENGTHS**

- Thermal Insulated
- Virtually Indestructible
- Light Weight

**PLASTIC DISTRIBUTORS & FABRICATORS
SPECIALIZING IN SERVICING THE
AGRICULTURAL MARKET**

- Cost Effective
- All types of Plastic Sheet, Rod and Tube



TRANSLUCENT ROOFING
AND WALL PROJECTS



ONTARIO FOOD
TERMINAL

www.plastechglazing.com

**SALES, RENTAL & SERVICE
SANDBLASTING & PAINTING**

**MANURE SPREADER
RENTAL**



Custom Rebuilding
Spreaders - All Makes



**NEW & USED PARTS
SHIPPING AVAILABLE**

**NEW! Cost Effective
Plastic Flooring**

New & Used Tires & Rims

New Beaters In Stock

Apron Chains

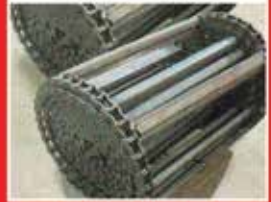

WAYNE MARTIN 519-669-4477

**WANTED: SPREADERS
FOR WRECKING & RESALE**

FACTORY DIRECT OUTLET

**DELUXE WOOD & WATER OUTDOOR FURNACES. CAN YOU FIND A CHEAPER WAY TO HEAT?
CSA APPROVED.**



FC30 HD UNIT
PLUS ACCESSORIES HEATS UP TO 1800 SQ. FT.

25TH ANNIVERSARY BLOWOUT!

**\$4997
- \$1500
\$3497**

**LIMITED
QUANTITIES!
ALL MODELS ON SALE!**

www.friesenbuilt.ca



CANADA'S BEST PRICE GUARANTEE ON COMPARABLE MODELS

855-897-7278 . 204-388-6150

Deluxe Air Cabins Available From 35-97 HP



XG-Series 25, 35, 40 HP
25 HP Mitsubishi, LS CRDI Turbo Diesel

Excel in Your Field™

XJ-Series

25 HP HST or gear transmission
quick attach bucket available



XR-Series 35-55 HP 12 or 16 speed shuttle
shift or HST transmission



P-Series 72-97 HP 20 speed mechanical
or 40 speed power shuttle
transmission



XU-Series 58-68 HP (68 HP tax exempt)
16 forward x 16 reverse mechanical or power
shuttle transmission

Dealers

www.LSTractorUSA.com

B & G Loughlin Tractors Inc. Mountain 613-989-3839
Bourbonnais Equipment Inc. Sarsfield 613-835-2623
Bromley Farm Supply Douglas 613-649-2457
J & H Sales & Service Chesley 519-363-3510

John's Equipment Sales
& Service Ltd.
March Road Motorsports
Milestone Equipment
Rusty's Power Washing
Vande Goor Ag Service

Frankford 613-398-6522
Mississippi Mills 613-256-6686
Millbank 519-656-9157
Courtright 519-332-9821
Norwich 519-424-3574



hbi.on.ca

730 TALBOT ST. WEST
AYLMER

H. BROER EQUIPMENT
sales. service. rentals

Toll Free 855-773-3100



THE COMFORT CAB

YT347/359
& Attachments

Come see Doug for a tour!

YANMAR



we sell genuine parts

HONDA
ENGINE'S



HATZ
DIESEL

Robin
SUBARU

HY-SPEC
EQUIPMENT

YANMAR

Smyth
WELDING
& MACHINE SHOP LTD.



519-529-7212
email info@smythwelding.com
web www.smythwelding.com
Auburn, Ontario

MANUFACTURERS OF SNOWBLOWERS, LAND ROLLERS, SWEEPERS, STONE WINDROWERS

3 POINT HITCH SWEEPER

- 24" x 6' brush
- PTO drive
- Rear mount 3 PH or front mount kits available
- Adjustable angle
- Adjustable Caster wheels
- Other sizes & models available



28FT FOLDING STONE WINDROWER

This Smyth built rake features a 28' raking path with a 5' windrow. Single remote hydraulics allows you to add the optional rear hitch to pull a hydraulic picker behind. Hydraulic depth wheels with manual depth stop lets you fine tune your working depth to suit your field conditioning and soil types. The large 24" diameter double spiral drum with narrow, hardened teeth means you move stones not dirt without excessive soil compaction.



VERTICAL WING LAND ROLLERS (VS)

Sizes from 22' to 34', over centre action requires no lock up, 30" diameter rollers, 3/8" thick material 2" main bearings cylinder & hoses included Transport lighting included.



SEE OUR GREAT PRODUCTS ON DISPLAY AT THESE SHOWS



Made in Canada

Maple Valley Sales & Service

793175 County Rd. 124 Creemore, ON L0M 1G0
 PH: 705-466-3138 FAX: 866-234-5305
 Email: sales@maplevalleysales.com www.maplevalleysales.com



COMMERCIAL 21



COMMERCIAL 30



TURF TRACER S-SERIES



LAZER X-SERIES



PB-255LN Blower

Echo lawn and garden products



PW4000 Pressure Washer



PB-770T Blower



FX65 Skidding Winch



WP835 Wood Processor



BXMT 3213 Chipper/Shredder

WX540 Splitte



WALLENSTEIN



Grillo

AGRIGARDEN MACHINES DIRECT

Grillo Walking /Two Wheel Tractors



A Grillo tractor is a very versatile piece of equipment. They are mainly used for tilling soil, but with the number of various implements which are available it allows your investment to really work for you all year round. A Grillo tractor gives the operator exceptional performance and strong construction coupled with ease of use. Looked after properly the machine will give years excellent and reliable service.



HOURS: MONDAY-FRIDAY 8 TO 5, SATURDAY 9 TO 12, SUNDAY CLOSED

CORRUGATED PVC

Better than plywood, cheaper than steel

AGRICULTURAL • COMMERCIAL • INDUSTRIAL

GARAGES

3 x 8, 12, 16, 20

Easy to Cut, Install, Clean

WORKSHOPS

White or Clear

Premium Quality

WASH BAYS

Plastic or SS Fastners

Made in Canada

BARNs

Stocked in 2 Locations in Central Ontario



519-923-9995
Dealer Opportunities
www.linwoodcorp.com



McINTYRE WELDING

DEALER INQUIRES WELCOME



RR 1 Singhampton, Ontario

Ph: 519.922.1696 | Fax: 519.922.1039 | Email: smartin@everus.ca

HG8 HAY & GRAIN FEEDER

- 2" round rails
- 1-5/8" round stanchions
- 7' x 8' or 7' x 13' pan designed for feed flow to 4 sides of feeder



MWR FEEDER

- Rugged cow & bull feeder
- 54" high • 1-5/8" round tube const.
- 8'4" diameter • 22" skirt
- All around material - no sharp edges
- Cattle can reach centre with less push on feeder



HRHF ROUND BALE FEEDER

- 1-1/4sq., .100 wall tubing
- 8'4" diameter
- 48" height
- 3 section round
- Long pin secure connections



H13 MULTI-BALE FEEDER

- 2" round rails
- 1-5/8" round stanchions
- 7' x 8' or 7' x 13' cattle can reach centre with less push on feeder



www.mcintyrewelding.com



FENDT

All farmers work hard.

But for the dairyman, it never quits.

Cows don't take vacation. They depend all the time, every day, on the dairyman to feed them and care for them.

For the dairyman it's a non-stop effort. So he needs a tractor that's up to the task and that won't let him down.

On more and more dairy farms, that means deciding to buy a Fendt tractor. Because for the many tasks you find on a dairy, there are things about a Fendt you just can't find on any other tractor for any price. Make a plan today to try the tractor that has The Best Run Operations—including many of the best run dairies—Run Fendt.



fendtfielddays.com

MOUNT FOREST
Maple Lane Farm Service,
519-323-4289

SPRINGBROOK
McKeown Motor Sales,
613-395-3883

 Fendt is a worldwide brand of AGCO Corporation. © 2014 AGCO Corporation • FT14C0051B



www.pjcanada.com

Toll Free 866.822.9662
414 Rocky Road, Leamington ON

COME SEE US AT



COME VISIT OUR TRAILER DISPLAY AT THE OUTDOOR FARM SHOW IN WOODSTOCK SEPT. 13, 14 & 15

Our Booth will be located at, 7th Lane in Middle Machinery Mall. Look for the PJ flag in the sky.



Single Axle Enclosed V-nose LED lights, barn or ramp doors, radial tires, plywood walls, dome light. Many to choose from

STARTING AT **\$3200**



Tandem Axle with v-nose, front stone guard, plywood walls, LED lights, side door, wall vents and dome light, ramp door or barn doors your choice. Aluminum wheels add \$300.

STARTING AT **\$4600**



We have a great selection of enclosed car trailers in stock, 3500lb or 5200lb axles, all with 48" side doors 20'-24' lengths in stock

STARTING AT **\$6900**



7 Ton Low Pro Dump Trailer, 24" deck height, 2-7000lb axles, Spreader Gate, Ramps, Roll Tarp, 12' and 14' lengths available.



Lots of goosenecks in stock. All with LED lights, tool boxes, powder coat finish. 25 in stock to choice from. 20' to 40' in length.



Equipment Trailers Call for our large selection of equipment trailers, ramp style, and tilts, many lengths and axles sizes to choose from.

CALL US FOR TRAILER PARTS

CHECK OUT OUR REDUCED PRICES ON TRAILER TIRES

205/75/R15
6 PLY

~~\$115~~
\$110



225/75/R15
8 PLY

~~\$160~~
\$125



235/80/R16
10 PLY

~~\$179~~
\$140



235/80/R16
DUAL
10 PLY

~~\$199~~
\$175



NEW!! ALUMINUM WHEELS AND TIRE SETS

*ALL PRICES INCLUDE RIMS SHOWN



225/75/R15
~~\$230~~
\$215



205/75/R15
~~\$175~~
\$160

Call for Aluminum Wheel pricing and details



235/80/R16
~~\$255~~
\$245

www.pjcanada.com

Is your pond smelly, full of muck & weeds, and an eyesore?
DREDGING IS YOUR ECONOMICAL SOLUTION!!

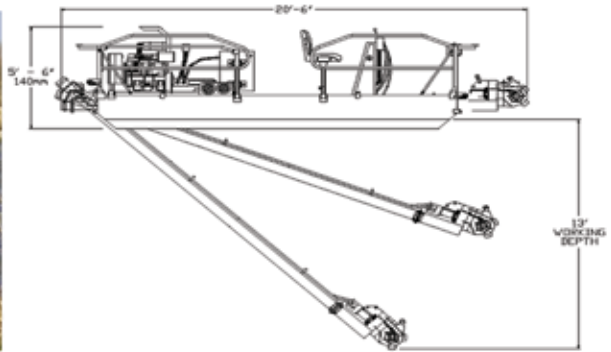

Cheaper than excavation and no mess when finished!

See a live DREDGING demonstration at
 Silvercreek Aquaculture - August 6-7, 9am-5pm
 Please RSVP.

Envir-O-Site Inc. 519-383-5114

Silvercreek 519-833-2559

SEATAINER BUY DIRECT FROM THE TERMINAL
TERMINALS INC. OVER 1600 CONTAINERS ON SITE TO CHOOSE FROM

SECURE DRY STORAGE CONTAINERS CERTIFIED FOR EXPORT



NEW & USED
 VISA / MASTER CARD / DEBIT



WIND & WATER TIGHT. STRUCTURALLY SOUND.

Get additional
 Saving with
 volume discounts

905.893.2932
 7050 Major Mackenzie Drive W.,
 Kleinburg, ON L0J1C0

1-647-212-9432
 Direct Sales Line

email: sales@seatainerterminals.com | website: www.seatainerterminals.com



POND STOCKING

Rainbow, Brown & Speckled Trout

AUGUST SPECIAL

6-8" Trout

.99¢

(min 100)

8-10" Trout

\$1.99

(min 100)

10-12" Trout

\$2.49

(min 100)

BASS AVAILABLE

Less than 100 add 50¢

August Aerator Special **\$1999⁹⁹**

4 LED Light set **\$799⁹⁹**



AQUA CONTROL EVOLUTION 6 Pattern Fountain

1/2 HP, high volume,
GFI/timer, 115V,
100ft cord



Buy both aerator & lights and receive \$100 discount & decorative fountain head - \$150 value

KOENDER WINDMILLS - includes 100' airline, airstone, check valve

Ontario's Best Price



Compare & Save

20FT WINDMILL

\$1449⁹⁹

24FT WINDMILL

\$1699⁹⁹

DELUXE PACKAGE

\$399⁹⁹

INCLUDES AIRLINE, AIRSTONE,
CHECK VALVE PLUS - FREEZE
CONTROL, TILT PACKAGE, 50'
WEIGHTED AIRLINE, DECOY DUCK
& 4L NATURE'S POND CONDITIONER,
SAVES \$150 IF BOUGHT SEPARATELY!

16FT WINDMILL

\$1299⁹⁹

**12FT POWDER COATED YARDMILL
COLOURS - RED/WHITE, GREEN/YELLOW, BRONZE**

\$599⁹⁹ COMPLETE WITH AIRLINE, AIRSTONE

WE SOLVE WEED, ALGAE & ODOUR PROBLEMS

**AQUATIC WEED
ERADICATOR**

Cuts weeds
easily



POND DYE



Blocks Sunlight

**NATURE'S POND
CONDITIONER**

\$99⁹⁹

Blue & bacteria all in one.
Add ASAP for improved
pond this Spring!



ASK ABOUT
OUR POND
CONSULTATION
SERVICE. TWO
PROFESSIONAL
BIOLOGISTS
ON STAFF.
60 YEARS
EXPERIENCE.

Problems with a mucky pond?

Come and see our pond dredging demo.
Weekend of August 6-7. Please call to RSVP.

LESS EXPENSIVE THAN EXCAVATION.

SILVERCREEK AQUACULTURE

Erin, Ontario - 519.833.2559 www.silvercreekponds.com

ENTER TO
WIN!

 **Husqvarna**[®]

240 CHAINSAW
14" BAR



Fill out a ballot at Canada's Outdoor Farm Show
for your chance to WIN!

Location: 5th Lane North & Ag-Biz Pavilion

Farms.com[™]
Ag BUYER'S GUIDE

The HEAVY DUTY WORK BENCH



Easy roll out heavy weight supporting drawers



Workbenches have a 1 piece welded frame

- Standard lengths of 6', 8', 10', 12'
- Easy roll heavy weight supporting drawers
- Heavy gauge ball bearing drawer guides



Drawers with heavy duty ball bearings

10 GAUGE STEEL TABLE TOP

... THAT WILL LAST THE TEST OF TIME & LABOR



September 13, 14 & 15
Booth located in the Ag Biz Pavilion



An affiliate of McTavish Steelworks

1128, Rang Ste-Geneviève, Roxton Falls, Québec J0H 1E0
HENRY DYCK | 450 204-3998 | henry@bluemetalindustries.com

www.bluemetalindustries.com

Eliminate High Heating Bills!

www.countryheat.ca
Authorized Central Boiler & Maxim Dealer

SUMMER PROMO

rebates up to

\$1000

on select models



Outdoor Furnaces

Maxim M250 Pellet Furnace



E-Classic Model
3 sizes available



Classic Model -5 sizes & dual fuel
propane or oil available



Country Heat INC.
Renewable Fuel Heating Systems

1-886-844-1344

Perry Millson - Owner & Installer
pmillson.countryheat@gmail.com

BE AWARE OF SCAMS

We do not charge a \$99 admin fee or a \$119 taxable title fee for a non taxable license



6' x 12' - \$4200



7' x 14' - \$5600

FLAT TOP V-NOSE TRAILERS

Flash Package that includes LED lights, RV Lock, Vents, Radial tires and ramp door -3/8" Plywood interior walls



All Aluminum
Snowmobile Trailers

CLEARANCE PRICED

FLAT TOP V-NOSE TRAILERS



Flash Package that includes LED lights, RV Lock, Vents, Radial tires and ramp door -3/8" Plywood interior walls 20' - 28' trailers in Stock Starting at \$8000



**WE HAVE JUST TAKEN
ON A NEW LINE OF MADE
IN CANADA MENNONITE
QUALITY TRAILERS**



AUTOSPORT & CARGO TRAILERS

By: **JIM BRAY**
& ASSOCIATES INC.

519-720-0777 • 1-866-376-0777

1356 COLBORNE ST. E. • BRANTFORD

905-466-2876 • OAKVILLE | 705-474-1770 • NORTH BAY

Your PTO Experts

WALTERSCHEID



- Hydr. Toplinks
- Hooks
- Balls
- Ball Coupling Systems



Weasler



STEMPLINGER

Block Weights up to 2500kg

Front Hitches & PTO's



SAUTER



SCHOLTEN'S MACHINERY

1492 Windham Rd. 12, Simcoe, ON

T: 519-429-3651 | C: 519-429-9142 | scholtensmachinery@bell.net

MACHINERIE AGRICOLE ST-CESAIRE

650 Route 112, CP 399, St-Cesaire, QC

T: 450-469-4081 | www.machineriesagricoles.com

MarTarp

Tarps, covers & upholstery

519-923-3500

info@martarp.com



Reinforced sleeves
and corners



**IS YOUR TRAILER TARP
IN NEED OF REPLACEMENT
OR REPAIRS? CALL NOW**

**LUMBER TARPS, MESH TARPS,
BALE TARPS, GARAGES, BOAT
COVERS AND MORE!**



www.martarp.com

JOB DONE RIGHT

TOOLS SIMPLIFIED.

The work day is full of tough decisions. The HLA 4-in-1 Bucket is an easy to use, time saving attachment designed for the fast moving landscape industry. It's combination of a durable bucket, clamp, dozer, and box blade allows the operator to move quickly from one task to another without needing to switch attachments.

Start simplifying your daily operations today by contacting HLA Attachments.



1-866-567-4162 www.hlaattachments.com www.horst wagons.com

ROAD FLEX
S U S P E N S I O N

Horst's proprietary Road Flex system provides full 4 wheel independent suspension, smoothing out the ride for your valuable combine heads and further reduces the stress on equipment and operators commonly associated when towing agricultural equipment.



HW16297

DANUSER®



BALFOR FORESTRY EQUIPMENT



SC700
TRACTOR 3PT BUZZSAW



BF100
TRACTOR 3PT CHIPPER



450
TRACTOR MOUNTED
PROCESSOR, CUTS,
SPLITS CONVEYS



WINCHES
3 - 8 TONS



9 TON
VERTICAL SPLITTER



LASKI STUMP GRINDER

- Wheeled or tracked undercarriage
- Tracked models have available remote control
- Kohler 38hp gas engine
- Variable track width down to 27"

ATV LOGGING TRAILER



ATV Logging Trailer Hydraulic power pack 10'6" reach crane with full rotation grapple 4wd trailer Remote controlled winch



ATTACHMENT BROOM PRODUCT LINE

- 36"x25" self propelled walk behind broom
- 9.5hp Kohler OHV engine
- Hydrostatic Drive, 20 deg. broom angle



RABAUD TRACTOR MOUNTED FIREWOOD PROCESSOR

- 40" carbide tipped circular saw
- In feed and 4m outfeed conveyor
- 13 ton splitter

USED RAM CLEARANCE



2010 RAM 2500 Laramie Crew 4x4
Cummins Diesel, leather, loaded, 147,749 km
#460272AA \$37,900



2014 RAM 1500 Laramie 4x4
Eco Diesel, one owner, 45,647km
#460626A \$41,995



2013 RAM 1500 Tradesman Crew 4x4
Hemi, 115,500 km
#460624A \$25,900



2014 Ram 3500 Laramie 4x4
Cummins Diesel, leather, loaded, 61,086 km
#85153 \$65,900



2011 RAM 2500 SLT Crew 4x4
Cummins Diesel, 147,725 km
#460193A \$37,900



2014 RAM 1500 Outdoorsman 4x4
Hemi, 43,848 km
\$36,900



2014 RAM 3500 Longhorn Limited Crew 4x4
Cummins, one owner, only 28,986 km
#460643A \$66,995



2012 RAM 1500 Reg Cab Sport 4x4
One owner, Hemi, 48,359 km
#460543A \$27,900



7976 Wellington Road 109, Arthur, ON
1-800-263-5382 www.arthurchrysler.com



COMMERCIAL GRADE PICNIC TABLES

SAVE YOUR BACK BUY ALUMINUM

NO ROT CEDAR

SAFE & STURDY SEATING

SKI LEGS MAKE MOVING EASY

Heavy duty design that's built to last.

Canadian made product.

SHIPPED RIGHT TO YOUR DOOR AT AN EXCELLENT RATE!

Volume discounts available.

From package to completed assembly in a matter of minutes.

Buy direct from the manufacturer.

IN STOCK READY TO SHIP!

ORDER ON-LINE AT www.duralumepicnictables.ca OR BY PHONE 1-877-698-0201

MEET THE GREENEST PLASTIC SHEET!



100% Recycled Plastic Sheet

Environmentally friendly

FusionForm™ technology provides unparalleled strength

FDA compliant for non-contact food construction

Easy to cut; A dream to machine and fabricate!

Available from 1/8" up to 1/2" thick

White 1/4" x 48" x 96" sheet - \$40.00 (min. 10)

Why is the price so low? You are buying directly from the mill! No middleman or sales people to pay!

Cut it, drill it, screw it, bend it, hammer it, clamp it, bolt it, weld it, use inside, use outside, use under water, bury it, drag it on the ground, drive on it, etc, etc.



Call now to order! **905-227-7900**

Protecting farmland for future generations with sustainable polymer manufacturing by keeping plastic out of landfill sites.



Makita's diversified line of Outdoor Power Equipment features advanced technology in:

**CORDLESS • ELECTRIC
4-STROKE • 2-STROKE**



Outdoor Power Equipment From
**A Brand
Canadians Trust**



EB7850TH



EK7851HD



EBH341U



EA6100P53E



**COME SEE OUR FULL LINE OF
OUTDOOR POWER EQUIPMENT**



**CANADA'S OUTDOOR FARM SHOW SEPT
13, 14 & 15. OUR BOOTH IS ON 6th Lane S.W.**

makita.ca | outdoorpower@makita.ca



WORK KNOWS NO REST



TRAIL
RANGER XP 470 EPS
PEARL WHITE



WORK
RANGER XP 570 SAGE GREEN



HUNT
RANGER XP 570
POLARIS PURSUIT CAMO

FIND YOURS TODAY AT:

**ORILLIA ALLANBYER'S
EQUIPMENT LTD.
705-325-2746**

SEE THE COMPLETE LINE AT
POLARIS.COM

When you demand the ultimate in productivity, Polaris delivers. Only the Polaris RANGER XP 570 has the power, comfortable ride and legendary RANGER work ethic to haul more, tow more, and get more done.
LEARN MORE AT POLARIS.COM

Warning: The Polaris RANGER can be hazardous to operate and is not intended for on-road use. Driver must be at least 16 years old with a valid driver's license to operate. Passengers must be at least 12 years old. Drivers and passengers should always wear helmets, eye protection, and seat belts. Always use call rebs or doors (as equipped). Never engage in stunt driving, and avoid excessive speeds and sharp turns. Riding and alcohol/drugs don't mix. All drivers should take a safety training course. Call 800-342-3764 for additional information. Check local laws before riding on trails.

LOOKING FOR FARM EQUIPMENT?



DOWNLOAD THE APP TODAY!

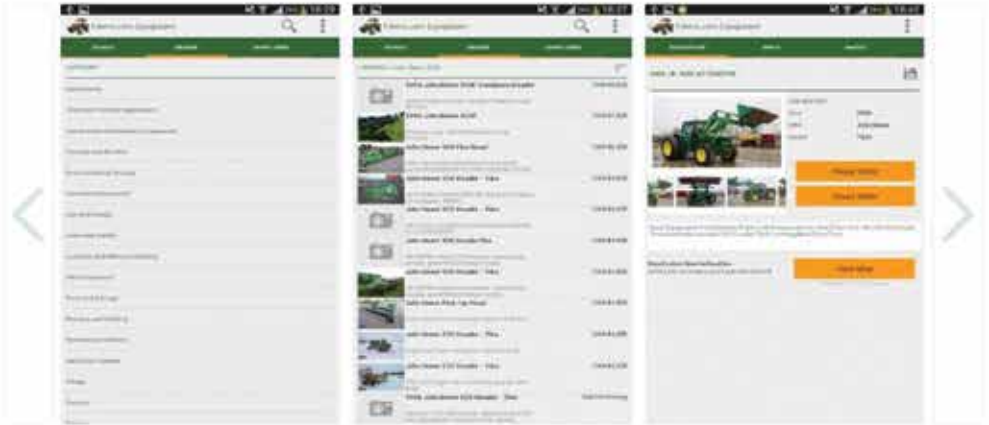

KEARNEY PLANTERS

Kearney Planters, Horsch & Drago Dealer

Thamesville, ON (519) 678-3206 | sales@kearneyplanters.com | parts@kearneyplanters.com

www.kearneyplanters.com



**NEW SERIES II
DISCOUNT PRICES.
LIMITED STOCK**

No other corn head in the field is engineered to capture more yield! Which will you choose? Drago Series II or Drago GT exclusive Trade In acre deals on current Drago customers. We welcome trades for Drago series I and series II.



Efficiency. Versatility.

AGRONOMIC INTEGRITY.

The next generation Joker RT from HORSCH gives you true efficiency, not only in working speed, but also the versatility of performing many different tasks with agronomic integrity. From preparing seedbeds that promote rapid emergence, precisely incorporating fertilizer and chemicals for maximum effectiveness, to shredding crop residues for fast decomposition, the Joker RT provides a single tool that will ultimately secure your inputs and potential yields. That means a better return on your tillage investment and more agronomic value to your operation.

www.horsch.com

HORSCH

Farming with passion

**KEARNEY PLANTERS IS NOW PROUD TO BE
A DEALER FOR HORSCH EQUIPMENT**



Professional Wash Systems

Come see us at Canada's Outdoor Farm Show
Sept 13, 14 & 15 - 7th Lane S.M.W.



Hot Water Washers



Floor Sweepers



Electric Power Washers



Floor Scrubbers

1-866-470-WASH or 519-655-2253

3982 Perth Line 26 in Stratford, On



Find us on Facebook

FREE DEMO

WWW.KARCHERPRO.CA

FREE DEMO

Toll Free: 1-844-YES-NBGI | Ph: 905-651-2803 | Email: James@nbgi.ca | www.nbgi.ca



Our final contract price is guaranteed,
with no hidden extra's!

Pre-engineered building solutions...
Fabric, Steel or Wood.
Big or Small we build them all.



Providing Our Customers With The Very Best In Building Solutions!



Agricultural / Commercial / Industrial / Equestrian / Recreational

Custom Built Mobile Washrooms

- Built on Heavy duty Trailer Frame
- Easy Towing
- Running Lights and 3 jacks
- 2 inch Sliding Hitch - Removable
- All Steel Construction
- Flush toilet and wall mounted sink
- 80 gal. Holding tank has side drain
- 20 gallon Fresh Water Tank
- Metal Insulated Door and Locks
- Interior Light and 1400 Watt Heater
- Paper Dispensers and Hand Cleaner Dispenser
- Easy to Clean and Maintain
- Available in your choice of colours



NEILMAN ENTERPRISES
by John & Steven Neilman

Hwy #9 Harriston
519-338-5995 (shop) | 519-338-3151 (eves.)

PIONEER 1

STEEL BUILDING

1.877.525.2002

100's of Sizes
30 Year Warranty

AGRICULTURAL | WORKSHOP | STORAGE | GARAGE

ECONOSPAN



from 20' wide - 40' wide x ANY LENGTH

ARCH BUILDING



from 19' wide - 100' wide x ANY LENGTH
Excellent for farm storage, hay storage or equipment storage

S-SERIES



from 20' wide - 60' wide x ANY LENGTH
Customize your own ends to suit your needs

S-SERIES



from 20' wide - 60' wide x ANY LENGTH
A wide variety of applications are available for the S-Series

SUMMER CLEARANCE



ALPINE

32'X50'X18'

Includes framed opening for a 14'x14' overhead, and a 4'x7' service door, excellent shop or storage building, comes with base connectors, foundation drawing & manuals.

\$14,500

SUMMER CLEARANCE



RIGID FRAME

40'x60'x16'

Rigid frame building available for small retail outlets to large industrial facilities. This size for

\$32,518

www.pioneeronesteel.com



CIRCULATING PUMPS



FAN DRAFT BLOWERS



UNDERGROUND PIPES



WE ALSO CARRY PELLET FIRED BAR-B-Q'S

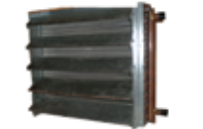

COMMERCIAL HEATERS



SOLENOIDS

WATER TO AIR HEAT EXCHANGERS



It's here! The brand new Woodmaster "CLEAN FIRE" ASME Certified Closed Loop Boiler. A revolutionary new clean burn system! We will be showing this amazing new unit at the Outdoor Farm Show and Plowing Match.

2016 CANADA'S OUTDOOR FARM SHOW - CANADA'S OUTDOOR PARK, WOODSTOCK | SEPT. 13, 14, 15
 2016 INTERNATIONAL PLOWING MATCH & RURAL EXPO - MINTO, ONTARIO | SEPT. 20 - 24

- RUSSELL MINERS - OWEN SOUND 519-376-7907
- GERALD SAUNDERS - TEETERVILLE WOODSTOCK 519-533-8774
- NOAH COBLENTZ - AYLMER 519-773-5467
- BILL ZANDBERGEN - BRINSTON 613-652-1786
- RICHARD TAYLOR - BURK'S FALLS 705-787-8982
- GREG BULLOCK - LINDSAY 705-341-4703
- TIMBER MART - EARLTON 705-563-2671
- NORTHLAND STORAGE - KAPUSKASING 705-332-1414

DEALER INQUIRIES ARE ALWAYS WELCOME PLEASE CALL:
JACK L. MINERS ONTARIO DISTRIBUTOR
 BURK'S FALLS - 705-387-4642

WE HAVE LEASING AVAILABLE

TOLL FREE 1-877-387-4642
 ALL DEALERS ARE TRAINED AND CERTIFIED

Do you know a top young farmer?

2016 Ontario's Outstanding Young Farmers' Award.

Visit www.oyfontario.ca for more information.

Awards Banquet to be held in Stratford, Tuesday September 13, 2016

Contact : Dianna Forth diannaforth@sympatico.ca



www.oyfontario.ca



Discounted units still available! While supplies last! call for details

Dealer/Installation/Service Info 1-800-261-0531
 Green Valley Shop 1-866-415-2127
www.greenvalleyheating.ca



HEATMOR™
 SINCE 1984



EPA Certified models available.

CANADA'S #1 SELLING STAINLESS STEEL OUTDOOR FURNACES USING 409 STAINLESS SINCE 1988

INDUSTRY LEADING GUARANTEE



Providing solid assurance in the exceptional quality, durability and strength of our products.

LEASING AVAILABLE

LOGSTOR

Insulated Flexible Pipe

LOWEST DOCUMENTED HEAT LOSS IN THE INDUSTRY

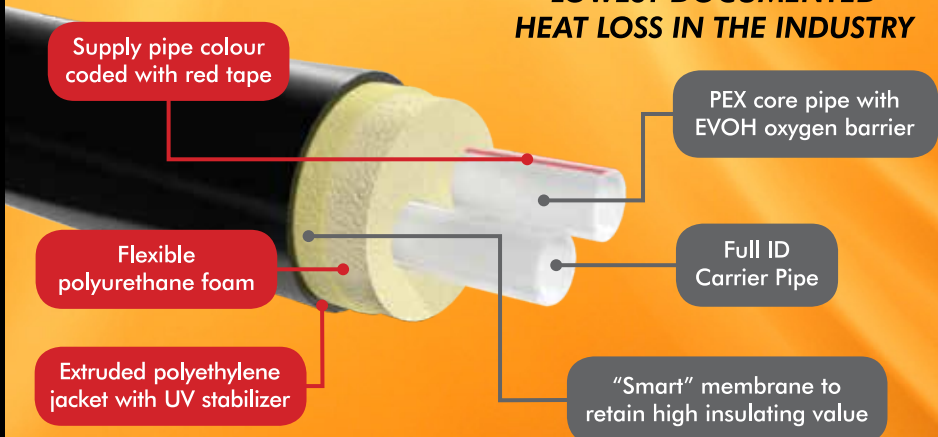

Jembrook Welding | West Montrose



James K. Bauman

General Welding & Farm Repairs

Loader Bucket Repairs

- In Stock 4" & 6"
- Wear bar For Bucket Repairs



We Recondition Units Tank Sizes Up To 6000 gal.

- Repairs to all makes

Financing Available Through National Leasing.

MANY RECONDITIONED UNITS IN STOCK

CALL US 519-669-5772

"MANUFACTURING QUALITY ROOFING, SIDING & TRIMS USING CANADIAN STEEL."



BUY DIRECT AND SAVE

FROM FLAT

TO FINISH

CONTRACTOR DISCOUNTS AVAILABLE

3 PROFILES OF ROOFING AND SIDING STEEL

- 20 Colours Available
- Flatstock
- Standard & Custom Trims
- Many Other Products Available



519-363-3757

2051 BRUCE RD. 19, R.R. 1, CHESLEY, ON N0G 1L0

www.Farms.com/UsedFarmEquipment



Search for **FARM EQUIPMENT** online!

Plus

Digital Version of the Ag Buyer's Guide



SEARCH 1000s OF EQUIPMENT LISTING

"I HELP FARMERS GET FARM LOANS"

My name is Elizabeth Gnoinski, Mortgage Agent. My parents owned a dairy farm in Ontario. My brothers and sisters all helped out with the farm. My dad got sick, the bank refused to give us time to sort out our finances, and we lost our farm through no fault of our own. I will never forget that!

I grew up and had a hobby farm. It was a tough go with brutal cold and snowy winters and a short growing season.

I UNDERSTAND THE CHALLENGES YOU FACE!

I became a licenced mortgage agent with **Expert Mortgage** so that I could help farmers across Ontario.

I specialize in **AGRICULTURAL LENDING**. With over 400 private lenders to back me combined with my farming background, **I work hard for you!**



Rates from **2.10%**
As of July 2016 OAC
— Based on 5 year term
35 years
Amortization on non working farms

Even if you have **BAD CREDIT & NO PROOF OF INCOME**, I can still help you.
I do RESIDENTIAL, COMMERCIAL & CONSTRUCTION LOANS too!

I REPRESENT OVER 400 LENDERS

Many provide 1st, 2nd and 3rd mortgages **even** with:

- Horrible Credit
- Bankruptcy
- Unemployed
- Mortgage Arrears
- Property Tax Arrears
- Power of Sale
- Self-Employed
- Pension & Disability

Does Your bank offer payments **THIS LOW?**

Mortgage Amount	Monthly Payment	Bi-weekly Payment
\$200,000	\$677.03	\$312.33
\$220,000	\$744.73	\$343.56
\$240,000	\$812.44	\$374.79
\$260,000	\$880.14	\$406.02
\$280,000	\$947.84	\$437.26
\$300,000	\$1,015.55	\$468.49
\$320,000	\$1,083.25	\$499.72
\$340,000	\$1,150.95	\$530.95
\$360,000	\$1,218.65	\$562.19
\$380,000	\$1,286.36	\$593.42
\$400,000	\$1,354.06	\$624.65



Ontario Premier Kathleen Wynn and Larry Davis from OFA with my daughter, 4H Beef Club Show Paris Fair 2013

CALL LIZ NOW
to put your mind at ease

As of July 2016 OAC



Call me 7 DAYS A WEEK for a confidential consultation
Toll Free Across Ontario 1-855-755-1904 or Cell 519-755-1904
Or send me a question online at liz@lizthewiz.com Visit www.LizTheWiz.com

Most banks underwrite loans using standard commercial lending guidelines that don't make any sense for farms. Being a Specialist in farm loans, I understand the farming community.

Talk to me if you'd like to ...

- Buy more land or new equipment
- Repair or construct new buildings
- Refinance your existing debts
- Buy quota

I can offer qualified farmers ...

- Up to 80% of **FULL** farm value
- Up to 30 year amortization
- Operating lines of credit

CALL ME EVEN IF EVERYONE ELSE HAS SAID NO!

With over 400 lenders at my disposal I can get you a mortgage even with...

- **Bad credit**
- **Poor cashflow**
- **Power of sale**
- **Mortgage arrears**
- **Tax arrears**
- **No financials**

EQUIPMENT **BUYING** **ATTACHMENTS** **SKID STEER**
PARTS **PLANTING** **TILLAGE** **CONSTRUCTION & INDUSTRIAL**
SELLING **HARVESTING** **TRACTORS** **HAY** **TRAILERS**
TILLAGE **GRAIN** **HANDLING**

WWW.FARMS.COM/USED-FARM-EQUIPMENT

TRACTORS



2012 John Deere 8260R
\$215,000



CIH Farmall 105N Tractor
\$57,500



2000 Landini MYTHOS 100
\$37,500

COMBINES



CIH AFX8230 Combine
\$299,000



2008 New Holland CR9060
148,900



1999 John Deere 9610
\$72,000

PLOWS



2011 John Deere 2700
\$45,000



Salford 6205 Plow
\$21,900



Kverneland BB115XP
\$12,900

BALE WAGONS



2014 John BM Mfg Ltd. 8.5x30' mesh rack
\$6,500



John Deere 716A
\$5,000



Creekbank Welding Hay Racks Wagon
\$3,400

Farms.com
BUYER'S AGUIDE

FIND THESE AND MORE AT
www.Farms.com/Used-Farm-Equipment

SMALL ENGINE REPAIRS NEW AND USED SALES

exmark

WE CARRY A FULL LINE OF EXMARK LAWN MOWERS



PROMO PRICE
\$9,999

LAZER Z E SERIES

QUEST S-SERIES FRONT STEER

TURF TRACER S SERIES



WOODSPLITTER

ECHO BEAR CAT

PW 3100
PRESSURE
WASHER
\$499



shindaiwa

SHINDAIWA
CORDLESS

ECHO
Echo Approved Dealer

- CHAINSAWS
- LOG SPLITTERS
- CHIPPER/SHREDDERS

- WHEELED TRAILERS
- BRUSH CUTTERS
- HEDGE CLIPPERS

- PRUNERS
- LEAF BLOWERS
- HAND TOOLS

CUSTOM TRAILERS

SPORT **\$999**
4' x 8'



- SOLID PLANK FLOORS
- HEAVY DUTY TUBE FRAMES
- SPRING LOCK TAILGATES
- DROP AXLE AVAILABLE
- CUSTOM ORDERS

UPDATE YOUR TRAILERS OR FARM
MACHINERY WITH NEW LED LIGHTS.
SEE BETTER, WORK BETTER.



BOAT IN A SAC... PERFECT FOR TRAVELLING!
Packs into a compact bag quickly and easily!
Available in various colours & 9 foot model.
Paddle or electric motor up to 10hp.
Affordable & compact!

**THE DREAM SERIES INFLATABLE
ALUMINUM RIGID BOAT!**

From fishing to racing... the dream series
with its many added features is your best multi
use watercraft option to enjoy the water.



Freedom inflatables
from \$999

ZEHR'S SALES • SERVICE
GAS • DIESEL • SMALL ENGINE REPAIR
3962 Line 72, Millbank **519-595-7579**

shindaiwa **BCS**
ECHO **exmark**

BLACKJACK

bigdogmowerco.com/blackjack

HIGHLIGHTS

- Patented automatic park brake system, built into levers
- Push-button deck lift/lower – easy cleaning and maintenance
- Push-button deck height adjustment – 1.5" to 4.5"
- Heavy duty fabricated steel deck
- Fabricated heavy duty steel frame – Best in Category
- Kohler Pro with Smart Choke - 3 yr. warranty
- Proven Hydro-Gear ZT2800 transmissions for smooth operation and extended life
- 20" drive tires
- Always-on LED lights
- Reinforced engine guard



TOP SPEED

7
MPH

20
SECOND
PUSH BUTTON
HYD DECK
LIFT

STARTING AT

\$6983

0% for 36 months OAC

7YR INDUSTRY LEADING
WARRANTY

BLACKJACK



BIG DOG
— MOWER CO. —

• BUILT *in the* U.S.A. • | [BIGDOG MOWER CO. COM](http://bigdogmowerco.com) | Big Dog makes a home.

YORK REGION EQUIPMENT
Keswick 905-478-1553 Markham
905-604-1797

BELORE TRAILERS
Mount Elgin 888-868-2804

KW OUTDOOR
Perth 613-326-0844

BOBCAT OF HAMILTON Stoney
Creek 905-643-3177

EVERNEW SALES & SERVICE
St. Joachim 519-728-0047

CANADIAN EQUIPMENT
OUTFITTERS
Innisfil 866-436-3471

LANDMAN ENTERPRISES Chesley
519-363-2663

E.R. VOLLANS LTD
Kingsville 519-733-5233

LD POWER SPORTS
Godfrey 613-374-5604

UXBRIDGE MOTOR SPORTS
Uxbridge 905-852-5884

ZEHR'S SERVICE
Millbank 519-595-7579

LAKEVIEW REPAIR
Bobcaygeon 705-799-0848

AGRI CON EQUIPMENT
Belmont 519-644-1000

LINDSAY USED TRACTOR Lindsay
705-324-8331

HARKNESS EQUIPMENT
Harriston 519-338-3946
Hickson 519-462-2019

TROTTER FARM EQUIPMENT
Alexandria 613-525-3120

DALEMAR OUTDOOR POWER
EQUIPMENT
Oakwood 705-953-9080

NATIONAL SMALL ENGINES
Kingston 613-384-0061

MARTIN'S SMALL ENGINES Elmira
519-669-2884

MOTORSPORTS PICKERING
Pickering 905-620-1171

READY TO WORK. (PLAY)

OFA MEMBERS SAVE
AN ADDITIONAL

8-10%

OFF OUR LOWEST
ADVERTISED PRICE

ON ALL HONDA ATVs.
SOME CONDITIONS APPLY



*Exclusive Honda.
One focus.
One responsibility.*



www.kwhonda.com • 465 Conestogo Road Waterloo, ON • 519 746-7900

HOME OF SPARE PARTS

Tractor & Combine Salvage - New & Used Parts

P: 519-625-8450 • F: 519-625-8485 • RR #1 2422 Line 43, Stratford ON



ALLIS 170
W/ CANOPY - \$5,250



IH 5288
\$17,500



FIRESTONE 35.5x32 20 PLY TURF TIRES
2- \$2,000 EACH



FORD 7700
PARTS



CIH MX 135 4WD
PARTS



JD 6620
\$12,800



JD 4425
PARTS



CIH FARMALL 105 4WD
PARTS



3 - JD 9500
PARTS



CIH 2366 RWA
PARTS



CIH 2388 RWA
PARTS



MF 8560
PARTS



STOLL EZ 20 W/ SOFT RIDE
FROM CIH FARMALL 1050 - \$3,500



2 - CIH 2188
PARTS



IH HYDRO 100
PARTS



CIH MX 270 FWA
PARTS



CIH 1666
PARTS

OVER 100 TRACTORS AND 120 COMBINES IN STOCK

We Carry The Following Product Lines:

A&I PRODUCTS | LOEWEN | ARGIS | SPAREX | HY-CAPACITY | BEPCO



1-866-885-2569

www.actiontrailers.ca

Get all your truck & trailer accessories with Action trailers

Installation available with all of our products, no need to worry about having to do it yourself, let the pro's do it for you at an affordable price



SPECIAL: Rugid Liner Tonneau covers for \$449
(tri-fold, 3 ply) - regular \$695

SPECIAL: TRAIL FX



4' oval welded ends
(power coated black running boards) **\$449**
(regular \$645)
upgrade to stainless steel for only **\$99**



SPECIAL: Back rack with mounting hardware \$299
(regular \$385)



SPECIAL: AVS Hood protectors \$99
(regular \$139)



HUSKY X-ACT LINERS - custom fit to your vehicle \$139
(regular \$169)



SPECIAL: HUSKY Mud flaps \$59.99
(reg \$99)

ACTION TRAILERS ALSO OFFERS: truck lifts, custom wheels and tires, Air ride suspension, Hitches, Truck bed liners, Bush guards, Tool boxes, Fender flares, pretty much any vehicle accessory you can think of, we can do it. Email our sales manager Tim Wood - tim@actiontrailers.ca for pricing on all your Truck accessory needs.



2015 KUBOTA RTV 400 gas engine, demo unit with roof & windshield. Call for pricing.



KUBOTA RTV X1120 diesel, demo unit - power steering. Call for pricing.



KUBOTA RA 2071 Rotary Rake. Call for details and price



KUBOTA M126GX 32 speed power shift trans, self leveling loader. - Demo. Call for pricing.



2016 KUBOTA M7060 Hydraulic shuttle, 4wd, 12 speed transmission, self leveling loader, \$ Call.



2015 KUBOTA M108 SDS, 32F/32R, 108 HP, 4 WD, Please call for pricing info.



USED KUBOTA L5030 4wd, factory cab with heat & a/c, hydrostatic transmission, front loader, front snow blower, front blade.



USED KUBOTA M9000 4wd, cab, loader 2865 hours. \$37,995.

DeBoer's Equipment

t: 800-661-7006 | e: sales@deboersequipment.com
www.deboersequipment.com | Elora, Ontario



Air Conditioning Specialist Est 1989

Country Air

HOSE KITS

JOHN DEERE RUBBER HOSE KIT

MODELS:
4230, 4240
4430, 4440
& 4630



CASE/IH HOSE KIT

MODELS:
7110, 7120,
7130, 7140
& 7150



COMPRESSORS



JOHN DEERE



KUBOTA



CASE



AGCO MASSEY

BLOWER MOTORS



AGCO MASSEY



JOHN DEERE



CASE



NEW HOLLAND

519.638.8941 or 1.800.283.9228

Find us on

info@countryair.ca | www.countryair.ca | 8016 Wellington Cty. Rd. 7, RR1, Moorefield (Drayton)

LAWLOR HAULAGE LTD.

ECO-FRIENDLY MULCHING MACHINES



2007 GMC 6500 TOPKICK
111,760 km 6 Cylinder Isuzu, 6 Speed Transmission Complete with Ontrux roll off system & deck
\$26,500



2007 SWENSON SPREADER
and Pre-wet / Anti ice system Mounted on a Ontrux roll off
\$5,000



2013 T-7 235 NEW HOLLAND TRACTOR
1018 Hours Comes with rear duals
\$139,250

NEED LAND CLEARED? We have BRON 275 and BRON 590 Mulching Machines that will clear brush, slash, thin vegetation and do site preparation and also clear stumps, roots to stabilize soil for replanting by working up to depths of up to 20 in.

Call us for an estimate and we can get the job done!
Call for details

705-325-4582/705-323-8195 www.lawlorhaulage.com



519-922-2108
408065 Grey Road 4 • RR#1, Maxwell

JON OLSEN 519-373-1161

Please call for item availability before you come to visit us.



FENDT 926 VOSTRO
5 remotes, Working cond., 50K trans 12,000 hours
\$44,500



NEW HOLLAND TV 140
5300 hrs, tires like new, loader. \$34,900



LIFT KING 5000LB FORKLIFT
4x4 Crab steering, Perkins Diesel Motor, Side shift, Mast, 6500 hours, 3 speed with shuttle shift \$8995



NEW HOLLAND L170 SKID STEER Hand and foot controls, aux. hyd, Cab heat and hyd mount plate, brand new tires. \$22,900



2000 CATERPILLAR 426C TURBO BACKHOE 4x4 2 Stick Controls Extend, 4 speed w/Overdrive, Power Shift, Rear, Plumbing, AC/Heat, \$26,500



NEW GRAIN BUGGYS
510 Bushel, includes tarp Lights and roller and up graded tires. \$17,900



GREAT PLAINS No Till Drill grass seed box. liq. fert., tank & pump. hyd markers. double disc openers & press wheels. 2 to choose from \$11,500



GENIE S60 MANLIFT 6800hrs, Everything works well, Like new tires, Dual fuel Gas/Propane, Back up Aux. power, 4X4. \$9995



VOLVO 45 TON EXCAVATOR
exc. condition. No leaks. Great undercarriage. Volvo D12C 6cyl motor 239hp. 15,000 hrs \$44,500



CAT 305C CR 5 ton Mini X w/cab heat & A/C rubber track. 4500 hrs. Swing away boom. Has all glass. Cat or JD controls. \$38,500



JD 50D MINI EXCAVATOR front blade, 3300 hrs. Rubber tracks, A/C & heat. JD or Cat controls. Yanmar Diesel motor. 2 avail. \$38,900



ZETOR 5245 Excellent running, 52hp zetor 5245, cab, 4x4 tractor with only 3400 hours, brand new rubber. \$8495



2016 Great Ontario Yield Tour

Follow the Great Ontario Yield Tour!

August 15th – 26th, 2016

Will yields be higher or lower
this year?

Will your basis be higher or lower?

The **Great Ontario Yield Tour** will take place in August. Teams will span out across the province to analyze the health and size of the corn and soybean crops to determine how the growing season is impacting the 2016 yields for the Ontario crop. With this information, the Farms.com Risk Management team and Tour sponsors will provide the 2016-17 grain forecast for Ontario Farmers.

HOSTED BY

Farms.com[™] Risk Management

maizex[™]

CANADA'S *Outdoor* FARM SHOW

ALPINE[®]

PLATINUM SPONSORS

BASF

CASE IH AGRICULTURE

GREENFIELD SPECIALTY ALCOHOLS INC.

JOHN DEERE

South West Ag Partners Inc.

Palmerston Grain

VERITAS

SILVER SPONSORS

Better Farming

MICHELIN

TIRECRAFT

BRONZE SPONSORS

COLLINS BARROW

PENTA

CONTRIBUTORS

DEXERON

WIN



TO FOLLOW THE TOUR VISIT:
RiskManagement.Farms.com/YieldTour



ON TWITTER:
#ONyield16

For more information call **Moe Agostino** at 1-877-438-5729 ext. 5040 or email risk@farms.com



Farm Properties

FOR SALE

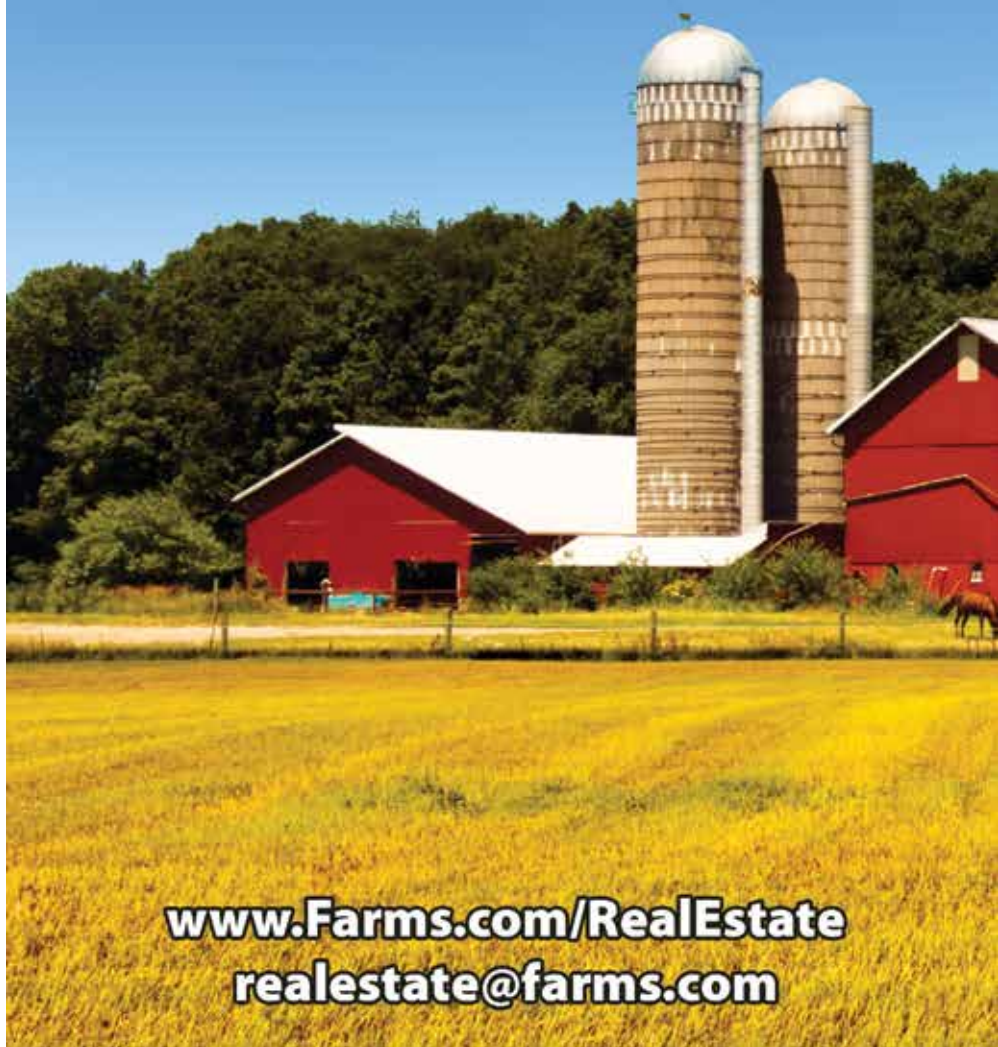

**www.Farms.com/RealEstate
realestate@farms.com**



Philip Chabot Broker
cell: 519-495-7117



JoAnne Baines Sales Rep
cell: 519-670-2660

Sutton Group-Select Realty Inc., Brokerage *Independently Owned and Operated*
250 Wharncliffe Rd. N., London, ON • Office: 519-433-4331

CALL PHILIP AND JOANNE, REPRESENTATIVES OF BONNEFIELD IN SOUTHWEST ONTARIO. WE CONNECT PROGRESSIVE FARM OPERATORS WITH BONNEFIELD... Canada's largest farmland investment manager and property management firm, dedicated to preserving 'farmland for farming' across Canada. Bonnefield and its farmland funds are 100% Canadian owned and controlled.

700 ACRES CHATHAM-KENT

Bare land, south of 401 hwy. All tilled. Call for details.

103.57 ACRES MIDDLESEX CENTRE

85 workable with some tiling. 2 homes, 25x40 outbuilding, driveshed, barn, bunkie. Possibility of severance. \$2,100,000 Listing #238.

198.54 ACRES BRUCE COUNTY

Bare land. 154 workable and possibility of clearing more acreage. Mostly systematic tilled, balance random tiling. \$1,410,000. Listing #66.

101.23 ACRES BRUCE COUNTY

Bare land. 80 Workable acres. Some tiling. Income from turbine lease. \$700,000. Listing #69.

148.77 ACRES BRUCE COUNTY

Bare land with 123 workable acres. Excellent yields at 185 bu corn and 50+ bu beans. 33' road access. End of farm owned by Seller. Elderslie silt loam. \$1,040,000. Listing #165.

SOLD

103.5 ACRES ESSEX COUNTY

All workable and tilled at 33 feet. 2 road frontages. 2 deeds. Municipal water at road. Brookston Clay soil. Small lot has been severed off. \$1,375,000 Listing #65.

78 ACRES SW MIDDLESEX

32 workable and 30 acres in pasture. Older home and older barn. Natural gas and municipal water. Possibility of severance. \$690,000. Listing #70.

ERIE SHORE VINEYARD

Be the Proud New Owner of this Award Winning, well run, efficient Vineyard and Winery on 37 acres with 30 acres in vineyard. By the shores of Lake Erie in the town of Harrow. Family owned and operated since 2002. House, Buildings, Winery and Winery Pavilion. Call for complete package. \$2,900,000. Listing #64.

NEW



Listing #238



Listing #66



Listing #69

SOLD



Listing #65



Listing #70



Listing #64

Looking for Manitoba farms? Please contact us for details.

INVESTMENT LEASEBACK OPPORTUNITIES AVAILABLE FOR BUYERS AND SELLERS

LOOKING FOR LARGE BLOCKS OF LAND SOUTHWEST ONTARIO

www.JustFarms.ca



Need a mortgage?

Having trouble with your mortgage? Not sure what to do? I can help if you are in need of emergency assistance... and need it FAST! Call me today or visit our website to find out how.

Are you a Home-Owner and need cash?
Call us now and get the most for the least.

Bad Credit - Bank Said No?

I can still help you!

- Horrible Credit • Bankruptcy • Mortgage Arrears
- Property Taxes • Power of Sale • Self-Employed • Pension & Disability

"No matter what your situation... I can help!"



VERICO
MORTGAGE BROKERS NETWORK
Each Verico brokerage is independently owned and operated.
License #12659

BRENDAN EBY
Mortgage Agent, VP

519-504-5523
brendan@cvmortgage.com
brendanebymortgages.com

CVE
MORTGAGE GROUP
INC.

ONE OF A KIND STONE HOME ESTATE



St. Marys, ON
Listing #262

165 years of history in this one of a kind stone home. 4 bedrooms, 4 fireplaces, 5 baths! 102 acres, 52 workable, 10 acres of newly fenced paddock, 40 acres of woodland, and two ponds. 40'x70' barn, insulated shop, 2 new horse stalls, concrete floors. Hookway Farm is not to be missed!

ADDITIONAL FARMS!

- Perth County Acreage with buildings
- Oxford County Beef opportunity
- Development Farmland Komoka
- Elgin County Crop land & elevator

90KG+ ONGOING DAIRY Moorefield, ON



90 acres, 75 workable. Almost 92kg quota, full closed herd. 132 freestalls and parlour, new in 2009. Includes herd, quota, feed, mixer, skid steer and mixing equipment. Century Stone home, steel roof, garage.
\$5,300,000 Listing #301



**Broker, *Sales Representative

**FARM
ONTARIO**
519-667-1800

Phil Spoelstra & Ron Steenbergen***
Re/Max Centre City Phil Spoelstra Realty Inc. and Re/Max Centre City Realty Inc. Brokerages
Independently Owned and Operated.

More Listings & Videos at

www.FarmOntario.com



WILFRED MCINTEE REAL ESTATE BROKERAGE
105 Garafraxa Street North, Durham ON N0G 1R0

Office
519-369-2128



93+ ACRE FARM

Property includes a 2 1/2 storey 4 bedroom red brick home with additions, bank barn with horse stalls, fenced paddocks and race track, good implement shed with 24'x40' heated shop. Land consists of approx. 75 acres workable, hardwood bush plus a small creek flows across entire property.

Listing 329 **\$785,000**



INCOME PROPERTY

This farm features a 2 storey Century home with 5 bedrooms and 2 baths. Out-buildings include bank barn, good shed or workshop and covered bunk silo. 70-75 acres workable, 15 acres pasture and 5 treed acres. Income of \$10,000/year from communication tower. Additional 50 acres across the road also available.

Listing 264 **\$975,000**



155 ACRES

Featuring a 3 bedroom bungalow, bank barn with additions, good implement shed and wood storage building. Land consists of approx. 70-75 workable, 35 acres cedar/softwood and 35 acres hardwood bush. Home has main floor family room with airtight woodstove, lower level is unfinished and has a walkout to landscaped yard.

Listing 542 **\$899,500**



Glen G. Reay | Sales Representative | Cell 519 369-4113
glen.reay@mcintee.ca • www.glenreay.com • www.mcintee.ca

Thinking of selling? Shortage of Homes for Sale Call Marg Today for Your Free Market Evaluation!

\$765,000

**PICTURESQUE HORSE FARM
ON 46 ACRES**

130 X 60' illuminated riding arena. Upgraded 14 stall barn with heated tack room. 7 paddocks. 5 bedroom Century home. Listing #503

\$899,000

BEAUTIFUL FARM ON 97.7 ACRES

70 workable, 30 potato land and 40 pasture and crop. 24 acres hardwood sugarbush. Bank barn, concrete paddock, shed, garage, workshop & 2 bedroom Century home. Listing #504

\$1,099,000

**99.25 ACRE FARM WITH
LARGE SHOP**

Large insulated shop with separate hydro and septic. Barn, cattle barn. Storage. 3 Bedroom house. Listing #505

Next door is 90.25 acres vacant land also for sale \$525,000. Listing #506

\$1,200,000

**152.38 ACRE FARM
- 2 DEEDS - EXCLUSIVE**

5 Bed Century Home, Barn & Sheds on 48.29 Acres plus 104.09 Acres Vacant Land across the road. 90 Workable Acres, 19 Hardwood, 40 Softwood Acres.

\$999,900

VACANT LAND

138.37 Acres close to Dundalk. \$999,900 Listing #508.

Building Lots for Sale. 1-14 acres starting at \$52,000. Call Marg Today!

For Successful Buying & Selling Call...



Marg McCarty, Broker, SRS
519-216-1756
marg@royallepage.ca • www.margmccarty.com

RCR Realty, Brokerage
INDEPENDENTLY OWNED & OPERATED



ONTARIO FARM GROUP

Ontario's Premier Farm Realtors Teamed Up To Better Serve You!

Matt Den Hollander
BROKER OF RECORD - OWNER
519.872.6259

Claude Robin
BROKER
519.291.8262

Kurt Keller
SALES REPRESENTATIVE
519.854.8081

Shawn Stanley
SALES REPRESENTATIVE
519.323.6554



Kevin Pasma
SALES REPRESENTATIVE - ASSOCIATE MEMBER
519.319.7355

Arjan Leeuwerke
SALES REPRESENTATIVE - ASSOCIATE MEMBER
226.228.6625

www.OntarioFarmGroup.com
REALTY EXECUTIVES PLATINUM LIMITED



ONTARIO
FARM
GROUP.com

interfarms®



DESIRABLE ACREAGE
New house, horse barn, 15 mins to London. \$667,000.
Listing 516



PRIME FARM LAND
Paved frontage, house & buildings, 401/403 location. \$1,200,000.
Listing 63



LOTS OF OPPORTUNITY
99+ Acres, nice 5 bedroom home. Woodstock area, call Justin. Listing 62



BRANT
62+ acres. 6 horse stall barn. Build your new home here. \$549,000.
Listing 514



PRINCETON
91 acres with 30x150' shop & storage shed. 2 ponds and well. Ideal for new home. \$845,000. Listing 563



NORWICH / BURFORD
72 acres, 4 bed home & storage shed. \$1,139,000.
Listing 513



PARIS: 56 acre, income earning equestrian boarding centre with two arenas and modern ranch home, plus 2 bedroom apartment. Call Alister or Justin. \$1,395,000. Listing 515



JUSTIN DESECK
Sales Representative
Call 226-926-7653
www.BuyAndSellOntarioFarms.com



Sutton Group Select
Realty Inc., Brokerage
Office: 519-433-4331
Independently Owned & Operated

ALISTER MACLEAN
CCIM Sales/Representative
Call 519-860-4113
www.farmsales.ca



DON'T BURY YOUR FARM IN THE CLASSIFIEDS

ADVERTISE IN OUR REAL ESTATE SECTION

Full colour ad for all sizes

Online listing at Farms.com Real Estate

Largest distribution of any Ag publication in Ontario

65,000 Farms read Ag Buyer's Guide every month

ann.hepburn@farms.com
519-803-7578





YOUR FARM CONNECTION

Culligan Real Estate Ltd., Brokerage
Head Office: 62 Ontario Rd., Mitchell, ON
519-348-4706



Howard Culligan
Broker of Record
519-272-5413



Allan Earle
Sales Rep
613-802-9797



Erwin Meyer
Sales Rep
519-671-9418



Alex Veens
Broker
519-274-5363

Please visit our website www.culliganrealty.com to view our listings!



Listing # 543

Englehart, ON

ONGOING DAIRY FARM

378 acres, 240 workable, systematically tiled. 56.6 kg quota, Tie stall barn for 58 cows, sheds, silos and 2 houses. Full line of equipment & herd included!



Listing # 544

Englehart, ON

ONGOING DAIRY FARM

83.6 kg quota. Excellent tie stall operation with 480 acres of workable land. 2 houses. All equipment and herd included!



DAIRY

40 kg existing milk quota. 480 acres, two houses, herd included.

Listing # 545

New Liskeard, ON

RABBITS - Grey County, ON

Large commercial turnkey operation. Located on 3 separate lots, 2 houses, 3 barns.

POTATO FARM - Earlton, ON

90 acres, profitable business, bungalow, warehouses, equipment included. Listing # 546

CASH CROP - Charlton Twp., ON

160 acres with 110 workable. Small house and barn. \$269,000. Listing # 548



IGOR POLISZCZUK, Salesperson

Sutton West Realty Inc., Brokerage
5415 Dundas St. W. Toronto, ON
Office: 1-877-503-3366 Cell: 416-528-8945

EXCLUSIVE LISTINGS

igor@strictlyfarms.com
Independently Owned & Operated

www.mcintee.ca • ivan.alderdice@mcintee.ca

102 +/- ACRE ORCHARD



50 acres in active apple orchard - Paula Red, Macintosh, Spy, Red Delicious and Ida Red. The orchard business and equipment for sale as well under a separate contract. 1956 sq ft, 2 bedroom bungalow, 2 barns - one with worker accommodation and storage building. Listing # 198.

\$987,000

50 ACRES OF FARM LAND



Contains 40+ workable acres, 3 bush acres and 6 acres of pasture. Excellent view towards Georgian Bay. Would make an excellent hobby farm. Listing # 197.

\$275,000



IVAN ALDERDICE, Broker
Wilfred McIntee & Co • 2 334 Sykes St. S. Meaford, ON
519-538-3240 office • 519-270-2356 cell





www.Farms.com/RealEstate

*Have you checked out the website yet?
More photos and information online!*

- Search by – Location (interactive map), Farm Type, Agent Name, Listing number from the print ad.
- See your Agent's information and find them on the interactive map.
- One click to email the Agent
- Lots of photos and videos
- User friendly, find what you want in a click or two
- Easy to find similar Farms without searching again
- Interactive Maps

**CHECK IT OUT
AND FIND
YOUR NEW
FARM TODAY!**



**Ann Hepburn | ann.hepburn@farms.com | 519-803-7578
www.Farms.com/RealEstate**

AGRIBUSINESS

RUSSELL, MANITOBA



Listing # 23

Berg's Hatchery, 3rd generation family business for sale. Distributes close to a million chicks a year! 6500 quota broiler breeder farm with pullet growing facility. Barns, house with garage, 89 acres of land. Includes all equipment and 5 delivery vans. Owners will train.

KAREN GORALUK, Salesperson
204-773-6797
 NorthStar Insurance & Real Estate

CASH CROP

RODNEY, ONTARIO • \$3,100,000



Listing #560

200 acres with multiple buildings and grain bins (70,000 capacity). Option to lease additional land. Could be used for Dairy, Cash Crop and so much more. 3 bedroom brick bungalow included. Also workshop and implement shed.

HEATHER COOK, Sales Representative
Cell 519-350-2989 • Office 519-692-3823
hcookrealty@gmail.com • www.mchomesrealty.ca
 M.C. Homes Realty Brokerage Inc.
 Independently Owned & Operated

BEEF

BELLEVILLE, ONTARIO



Listing # 327

164 ACRE FARM on 401. PRODUCTIVE CASH CROP LAND! BEEF FARM! 5 great outbuildings. Approximately 100+ workable, 1500 feet frontage on 401. Restored VICTORIAN BRICK home with new brick addition. Updated! Full of charm. Wood lot, stream. 5 min to Belleville, 10 min to Trenton. **Motivated seller, try an offer.**

DANIELLE VALENTIK, Sales Representative
Cell 613-847-4547 • Office 613-696-9907
daniellev@xplornet.com • www.daniellevalentik.com
 ReMax Quinte Ltd., Brokerage
 Independently Owned & Operated

INGLESIDE, ONTARIO • \$529,000



Listing # 534

60 Acre Hobby Farm with extra large Century home, extra large barn and new garage. 25 workable acres, 23 bush and 12 pasture. Home is renovated, everything is new - windows, doors, heat, bathrooms, kitchen, so much more! Must see the photos! Young fruit trees, grape vines, gardens and pond. Older retired couple, downsizing due to health reasons, must move before end of Summer. Open to reasonable offers.

HELENE OAKES
613-537-4407 • oakfarmstead@xplornet.ca
 Sale by Owner

THORNBURY, ONTARIO • \$799,000



Listing # 502

Working Cattle Farm. 58 Acres in the Beaver Valley. Barn is in new condition. Tile drained pastures. Century Home with 9' ceilings, glazed windows and huge kitchen. Geothermal forced heat and air. Three bedrooms, pool, and outdoor entertaining areas. More details and photos at toddbrooker.com.

TODD BROOKER, Sales Person
705-888-1818
 ReMax Four Seasons Realty Ltd., Brokerage
 Independently Owned & Operated

COBDEN, ONTARIO • \$570,000



Listing # 56

88 Acre farm, cash crop or cattle capability, with the centerpiece being a well maintained large 5 bedroom, 2 bathroom farmhouse. Surrounded by solid out buildings; main barn, pole barn addition, grainery, machine shed and detached garage. Gentle sloping 80+ acres of cultivated and cleared quality black clay soil. Enhanced by 550 feet of family friendly waterfront on Muskrat Lake.

LLOYD LEVESQUE, Salesperson
Cell 613-433-6224 • Office 613-646-9853
lloyd-levesque@coldwellbanker.ca
 Coldwell Banker Valley Wide Real Estate, Brokerage
 Independently Owned & Operated

SMOOTH ROCK FALLS, ONT • \$1,200,000



Listing # 164

617 Acres. Smooth Rock Falls in northeast Ontario Great Clay Belt, funding avail for beef/cattle start-up operation, 1hr from Airport, surrounded by Crown land, taxes \$550/yr, 144 workable, grant avail for tiling/clearing, pastures fenced w/water bowls, buildings excellent condition, large heated work shop, garage, barn, implement shed, high quality custom house, solar income until 2032.

LOLA DALLAIRE • 705-338-1074
 Sale by Owner

ARISS, ONTARIO • \$1,995,000



Listing # 549

80 Acre farm, 72 tillable - share-cropped. 3 buildings with 22,000 ft² of indoor storage / warehouse space. 2 leased and 1 used for off-season storage. House is 2 1/2 storey with geothermal and updated bathrooms also currently leased.

PAUL BOLGER
519-569-0812 • bolger19@rogers.com
 Sale by Owner

FOR SALE BY OWNER



Do you have your farm for sale privately? We would love to have your listing appear here. Get to 65,000 Ontario Farms with your print ad, and get listed on Farms.com Real Estate as well - one low price! Contact Ann Hepburn today: Ann.Hepburn@farms.com

519-803-7578
 Contact Ann Hepburn

FARMS.COM
AG BUYER'S GUIDE

HAMIOTA, MANITOBA • \$2,950,000



Listing # 3

Approximately 1438 acre farm. Mostly grain, but has been used for training horses as well. 2 yard site. Lots of good outbuildings including work shop with heated floor. Very nice area. Land is well suited for a mixed farm operation or straight grain farm.

SANDY DONALD JR., Sales Representative
Cell 204-724-5743 • Office 204-725-8847
www.sandydonald.ca
 Royal LePage Martin Liberty Realty, Brokerage
 Independently Owned & Operated

DAIRY

ORWELL, PEI • \$3,101,500



Listing # 536

Dairy farm for sale with 47.5kg quota. 14 outbuildings and barns. 4 bedroom house with 3 bedroom in law suite. 160 head of cattle with 50 milkers, 30 already bred. 30 pieces of equipment, all in mint condition.

KEVIN QUINN, Realtor
902-629-0201

kevin.quinn1@pei.sympatico.ca • www.peirealestateagent.com
Re/Max Charlottetown Realty Ltd., Brokerage
Independently Owned & Operated

HURON COUNTY, ONTARIO



Listing #10

49.7 kg. quota organic dairy farm. Great 76 free stall dairy barn on 140 acres. 109 workable, mostly sys. tiled. Naturally ventilated, double 8 swing parlour. Nicely renovated 4 bedroom home. Complete with livestock and barn equipment. Equipment and additional land also available.

JOHN JANTZI, Sales Representative • cell: 519-571-3894
KEVIN WILLIAMS, Sales Representative • cell: 519-572-2293
Re/Max a-b Realty Ltd., Brokerage 519-273-2821
Independently Owned & Operated

LET US HELP WITH

Use your time for getting listings, and selling Farms, let us handle the advertising. One price – print and digital advertising all over Ontario.

Contact Ann Hepburn today:
Ann.Hepburn@farms.com

519-803-7578
Contact Ann Hepburn

HORSE/HOG

THEDFORD, ONTARIO • \$795,000



Listing # 210

Beautiful Organic Farm. Tremendous income opportunity as a horse, garlic, cash crop or orchard. 4 bedroom ranch home on 102 acres, 67 workable. Updated windows & doors, roof and bathroom. Woodstove and forced air propane furnace. Solid barn, drive shed, cold storage, garage, workshop. Much more! Must see! MLS576014

LEO SHANAHAN, Sales Representative
Cell 519-878-5981 • Office 519-849-6783
leo@shanahanrealty.com • www.shanahanrealty.com
Shanahan Realty Inc., Brokerage

WAWANOSH TWP., ONTARIO • \$900,000



Listing #25

75 acre hog farm with 4 bedroom house, 36x40 barn and 84x40 barn with capacity for 600 finish hogs. Auger and hopper feeding and a hammermill make feeding and chores easy. Also includes a 42x100 coverall storage shed. 50 acres are zoned aggregate, giving this farm potential gravel sale income.

JOHN JANTZI, Sales Representative • cell: 519-571-3894
KEVIN WILLIAMS, Sales Representative • cell: 519-572-2293
Re/Max a-b Realty Ltd., Brokerage 519-273-2821
Independently Owned & Operated

HOBBY

MORRISBURG, ONTARIO • \$1,700,000



Listing # 561

90 acres comprised of 4 deeds. 20 acres Commercial Highway, 35 acres with 15 stall horse barn and 1/2 mile training track. 35 acres with 3 bedroom Cape Cod house. Fish pond, fenced property. Just off 401 at Hwy 31.

RICHARD WAGNER
613-543-4442 • barblauzon@gmail.com
Sale by Owner

ETHELBERT, MANITOBA • \$269,900



Listing # 535

Immaculate 3 bedroom home with many updates, including living room addition, new cupboards, laminate floors, windows and more. 198 acres perfect for Hobby Farm, livestock or horses. Lots of trees and landscaped yard.

JOHN ANDRES, Sales Representative
204-638-7947 • john.andres@century21.ca
Century 21 MacMillan.com
Independently Owned & Operated

LANGTON, ONTARIO • \$799,000



Listing # 233

Hobby Farm. 100 Acres, 65 workable in well drained soil. No Tile. Ideal for ginsing or vegetable production. Currently in tobacco, rye and hay. New metal roof on house and main barn. 30+ acres hardwood bush not been logged in over 20 years.

ROBERT ABBOTT, Salesperson
Cell 519-550-1672 • Office 519-688-0234
T.L. Willaert Realty Ltd., Brokerage
Independently Owned & Operated

FIND OUT MORE ONLINE



Enter the listing number from under the picture on any ad at our website; www.farms.com/RealEstate and get more information and more photos!

Book your ad in the Real Estate Classifieds next month!

ANN HEPBURN
ann.hepburn@farms.com – 519-803-7578

MORTGAGE

FARM MORTGAGES Making Farm Mortgages Simple



- 34 Years private business experience
- Bank being difficult?
- Difficult issues? Urgent Funding?
- Bax Mortgage Group #11036

What's important is that you feel at ease to call and see what I can do for you. No false promises, no nonsense, let's keep it simple.

COMPETITIVE RATES • SIMPLE PROCESS • CONFIDENTIAL ADVICE

REG BARNES, Mortgage Broker
519-670-8542 • reginaldbarnes@yahoo.com
Specializing in Farm Mortgages

Antiques	1000	Construction & Industrial Equipment		Post Hole Diggers	6640
Auctions	1050	Backhoes & Loaders	5210	Power Units	6650
Buildings & Storage		Blades/Scrapers	5220	Precision Ag Equipment/ Software	6660
Bins	1110	Dozers	5230	Miscellaneous	6690
Building Supplies	1120	Excavators	5240	Parts & Salvage	
Farm Buildings & Shelters	1130	Forklifts	5250	Ag Parts	6710
Storage & Containers	1140	Graders	5260	Dismantled	6720
Careers/Employment	1200	Telehandlers	5270	Motors	6730
Events/Announcements	1300	Other	5290	Tires, Duals, Rims & Chains	6740
Fencing & Gates	1350	Forestry & Woodlot		Truck Parts	6750
Generators, Engines & Power Supply	1400	Chippers/Splitters	5310	Other	6790
Livestock/Poultry/Pets		Other	5390	Planting & Seeding	
Beef Cattle	1610	Grain Handling/Storage		Air Seeders/Air Carts	6810
Dairy cattle	1620	Augers/Elevators/Conveyors	5410	Drills and Caddies	6820
Horses	1630	Grain Bins and Equipment	5420	Planters	6830
Livestock Equipment	1640	Grain Dryers	5430	Other	6890
Livestock Services & Vet Supplies	1650	Grain Vacuums	5440	Skid Steer Loaders	
Poultry	1660	Other	5490	Skid Steer Attachments	6910
Sheep & Goats	1670	Harvesting		Skid Steers	6920
Swine	1680	Combines	6010	Track Loaders	6940
Other	1690	Cotton Pickers/Strippers	6020	Other	6990
Miscellaneous Products		Grain Carts	6040	Tillage	
Books & Magazines	2010	Gravity Wagons	6050	Discs	7010
Energy Products	2020	Headers - Corn	6060	Field Cultivators	7020
GPS & Precision Ag	2030	Headers - Flex	6070	Mulch Finishers	7030
Heating & Firewood	2040	Headers - Other	6080	Plows/Rippers	7040
Other Items	2090	Headers - Trailers	6090	Rotary Hoes	7050
NEW Real Estate	Page 89	Pull-Type	6100	Row Crop Cultivators	7060
Seed/Feed/Crops		Rotary	6110	Vertical Tillage	7070
Chemicals & Crop Care	3500	Self-Propelled	6120	Other	7090
Feed Grain	3510	Windrow	6130	Tractors	
Fertilizer	3520	Other	6190	4WD	8100
Hay	3530	Hay and Forage		Loader Tractors	8200
Seeds	3540	Bale Wagons/Retrievers	6310	Other	8490
Straw & Bedding	3550	Balers - Round	6315	Trailers	
Other	3590	Balers - Small Square	6320	Dry Van Trailers	8500
Services & Contracting		Balers - Large Square	6325	Dump Trailers	8510
Construction & Demolition	4020	Disc Mowers	6330	Enclosed Trailers	8515
Custom Services	4040	Forage Harvesters	6335	Flatbed Trailers/Equipment Haulers	8520
Drainage	4060	Forage Headers	6336	Hopper/Grain Trailers	8530
Electrical & Plumbing	4080	Forage Blowers/Boxes	6340	Horse Trailers	8540
Insurance Products & Services	4100	Mower Conditioners/ Windrowers	6350	Livestock Trailers	8550
Legal, Accounting & Finance	4120	Rakes/Tedders	6355	Refrigerated Trailers	8560
Painting & Coatings	4140	Rotary Mowers/Sickle Mower	6360	Utility Trailer	8580
Tree Clearing, Mulching & Planting	4160	Stalk Choppers/Flail Mowers	6370	Other	8590
Water Wells, Treatment & Drilling	4180	Tub Grinders/Bale Processors	6380	Trucks & Automobiles	
Other	4190	Other	6390	Cabover Trucks	8610
Attachments	5000	Lawn and Garden		Conventional Trucks	8620
Chemical/Fertilizer Applicators		Outdoor Power Equipment	6400	Conventional Trucks w/Sleeper	8630
Fertilizer Applicators - Anhydrous	5110	Riding Lawn Mowers	6420	Farm/Grain Trucks - Heavy Duty	8640
Fertilizer Applicators - Dry	5120	Snow Removal	6440	Farm/Grain Trucks - Medium Duty	8650
Fertilizer Applicators - Liquid	5130	Other	6490	Pick-Up Truck 2WD	8660
Floaters	5140	Livestock and Manure Handling		Pick-Up Truck 4WD	8670
Sprayers - 3 pt/Mounted	5150	Chutes/Fencing/Handling	6520	Other	8690
Sprayers - Pull Type	5160	Feed Grinders/Mixers	6540	Recreational Vehicles	
Sprayers - Self Propelled	5170	Feeders/Waterers/Barn Equipment	6560	ATVs & Utility Vehicles	9100
Other	5190	Manure Handling/Spreaders	6580	Boats	9200
		Other	6590	Motorcycles	9300
		Other Equipment		RVs	9400
		Blades/Box Scrapers	6620	Snowmobiles	9500
		Irrigation Equipment	6630	Wanted	9800

EVERYTHING
You're Looking for
CLASSIFIEDS

Deadline for
September is
August 16, 2016
4:00

POST YOUR
FREE*
CLASSIFIED
IN THE NEXT
ISSUE OF
AG BUYER'S
GUIDE AS
WELL AS
ONLINE
TODAY!

* FREE TEXT LISTING
UP TO 140 CHARACTERS
IN PRINT.

www.farms.com/classifieds

abgclassifieds@farms.com

866-519-4302

Mon-Fri 8:30am - 4:30pm

800.471.0799

226.212.0787 by text

ANTIQUES

ANTIQUES

1000

www.DiamondFarmTractorParts.com

NEW! TRACTOR PARTS
SPECIALIZING IN ENGINE REBUILT KITS,
CLUTCHES, CARBURETORS, CRANKSHAFTS,
MANIFOLDS, RADIATORS, TURBO CHARGER
STARTERS, WATER PUMPS, RIMS, ELECTRONIC
IGNITIONS & 1000S OF OTHER PARTS



CELEBRATING OUR 40th YEAR
OF QUALITY SERVICE
1974-2014

COMPETITIVE PRICE QUOTES!
1-800-481-1353

TRACTOR SERVICE MANUALS!

DIAMOND FARM TRACTOR PARTS • DEPT.BG14
16385 TELEPHONE RD. S., BRIGHTON, ON K0K 1H0



1949 VA CASE clean with no rust
at all, very original, runs excellent.
\$1600. 519-503-1130.



MASSEY HARRIS 30 1949 new
battery, coil, points, unrestored,
has brakes. \$1750. Dan Seifried,
Harriston. 519-338-2688.

COCKSHUTT 20 DELUXE, runs nice,
new back tires, \$3500. 613-206-2666
or 613-314-2654.

MH 44 GAS TRACTOR, exc shape.
519-369-2262.

1951 CASE 50 TRACTOR, exc shape,
\$3000. 519-485-3344.



**GEORGE WHITE 6 THRESHING
MACHINE** has straw chopper, plus
belt, on rubber, 24 inch. \$1100. Dan
Seifried, Harriston. 519-338-2688.



9N FORD TRACTOR nice straight
original, excellent running condition.
\$2200. 519-503-1130.

IH MCCORMICK FARMALL 100, 3
sets of cultivators, 2 mid-mount, 1
rear mount, I.H side dresser, many ex-
tra attachments, exc cond, Please see
Kijiji ad id# 1165515728 for pictures,
\$6000. 705-559-5050.

ANTIQUE BEAM SCALE, Gold
Grand model 903, 1200lbs capacity,
24" sq platform, steel castors, \$350.
519-357-7410.

MASSEY HARRIS 44 TRACTOR, re-
built engine, working cond.
705-563-2180.

COCKSHUTT 20, all original, paint
& decals, good tires, won best unre-
stored at local shows. 905-957-3442.

JD B. ORCHARD, late '47, Serial
#336599, electric start, runs good,
\$5000. 905-957-3442

1956 ALLIS CHALMERS WD, for
parts: 4 cyl & manual trip bucket, large
hyd reservoir, 4 controls and more.
613-253-2640.

4 - MILK CANS, 80lbs. 519-462-2650.

FREEMAN FARM LOADER, for
antique tractor, trip bucket & sub
frames, fits 8N or 9N Ford or similar
Massey, very good shape.
705-844-1493.

ANTIQUE CAPTAINS CHAIRS, 3
captain, 5 others, some need repair.
519-348-8170.

1970 FORD FIRE TRUCK, \$2500
613-735-6602.

New One-Piece

DOORS

507-426-8273

- AG DOORS
- SHOP DOORS
- BARN DOORS
- AVIATION

CANADIAN CONTACT:
PRESTIGE GENERAL CONTRACTORS
519-366-9986

HYDRAULIC — OR — BIFOLD
"One-Piece" DOOR — STRAP LIFT and auto latch

SCHWEISSDOORS.com

The Door Leader

...Lift Straps

OLIVER 77 ORCHARD TRACTOR needs back fenders, true orchard tractor, has side panels on the motor. 519-395-5080.

MCCORMICK DEERING 04 ORCHARD TRACTOR, hand clutch, back fenders have been cut half way on the round of the fender. 519-395-5080.

1939 CASE R TRACTOR, restored, \$7500. 519-485-3344.

MCCORMICK FARMALL 100, L59 Woods belly mower, \$2250. 519-485-3344.

IH WIDE FRONT END M-450, tie rods in rear, good shape. 519-627-3756.

1946 JD "A" TRACTOR, in "show-room" cond. Delaware. 519-652-5393.

FORDSON MAJOR TRACTOR, mounted Ford 1R corn picker, good cond. Delware. 519-652-5393.

1 ROLLOMATIC FRONT END, for JD A tractor, good cond. Delaware. 519-652-5393.

1950S MH MUSTANG TRACTOR, 3pth, exc shape, scrapper blade, runs well. Delaware area. 519-652-5393.

INTERNATIONAL PLOW, 2 furrow, 3pth. 519-475-4772.

FORD FERGUSON PLOW, 2 furrow, 3pth. 519-475-4772.

ALLIS CHALMERS TRACTORS, 220 - 1970 & 210 - 1972. 519-501-6221.

AC COLLECTION, D Series D10 thru D21, complete pkg. \$65000. AC 200, \$7800. D14, \$2975. D17 ldr, \$4,000. I-400 Industrial w/ldr, \$6750. 519-392-6633 or 519-392-8543.

1955 CASE DISC, 10' wide, 32 plates with cleaners, manual lift, 2 axels, no damage, \$700. 519-872-2188.

FRONT END LOADER, will fit on a W4 International McCormick, no pump, \$100. 705-983-2156.

1948 OLIVER 66 ROW CROP, c/w wheel weights cultivators, like new cond. \$4000, OBO. 226-268-0660.

AC D17 SERIES IV TRACTOR, partially restored, gas, all new rubber. 905-396-7533.

MASSEY-HARRIS COMBINE, 10' cut, with cab, for parts only, no engine. 705-983-2156.

MASSEY-HARRIS #26, 2 furrow, drag plow, with #30 bottoms, \$300. 705-983-2156.

INTERNATIONAL 3 FURROW PLOW, working cond, OBO. 705-983-2156.

COCKSHUTT 30, with front end loader, \$2000. 705-983-2156.

CHRYSLER INDUST 6CYL FLAT HEAD, not working, c/w berkley b4JQ pump, as is, \$500. 519-484-2633.

CASE 600 TRACTOR, dual range, casomatic, not running at the moment, good tin and tires. 519-699-5363.

MH 44 TRACTOR, for restore or parts. 519-527-1482.

1951 AC TRACTOR, good looking, runs exc, new battery, complete engine tune up, many extra parts: pistons, sleeves, crank, cam, 12V generator, no time to enjoy, like to find a new home, \$2000, OBO. 519-373-6824.

INTERNATIONAL TRACTOR 806 Gas, 4500 hrs, 18.4/38's, like new, flat top fenders. BO. 519-683-6175. 519-683-6175.

ALLIS CHALMERS B, Restored. \$1850.

ALLIS CHALMERS B, Original condition. \$1350.

ALLIS CHALMERS CA, Original condition. \$1650.

ALLIS CHALMERS C, High crop with wide front end. \$1250.

ALLIS CHALMERS WD, Nice original shape. \$1350.

INT MCCORMICK CUB, c/w front blade. \$1850.

1962 CHEV, 4 door, hard top, ps/ pb, 283 auto, mild custom, \$3500 or trade.

519-520-1779.

CARS, 1974 Dodge Dart SE, all original, 1965 Chevelle Malibu, both are 4 door. 519-665-2303 bosomworth@wightman.ca

1928 X RUMELY TRACTOR, good running cond, \$17500, OBO. 705-435-8414.

1936 MASSEY HARRIS GP TRACTOR, 48" wide, indust wheels, ribbed tires, was running 3 years ago, Serial #303398-48, other GP parts avail. 613-822-1914.

ALLIS CHALMERS B, runs well, \$1250. 705-835-6749.

IH A, starts and runs well, \$1250. 705-835-6749.

#72 ALLIS CHALMERS COMBINE, good condition. \$1000. 705-835-6749.

MASSEY HARRIS FERGUSON TO 35, 3pth, trip bucket, \$3000. 613-577-3941.

INT U 300, front end loader, complete with forks, \$1500. 519-482-7901.

1978 MERCURY MARQUIS, 125000km, 4 door, hard top, loaded, climate control, cruise control, one owner, NO winter driving. 519-881-3219.

1951 IH INDUSTRIAL I4, 1941 W-4 w/ new back tires, not running, 1000ea. 905-983-9331.

2 ROW SCUFFLER, horse driven, B.O. 519-848-3090, leave message.

BELT PULLEY DRIVEN MAURE LOADER, last used on Oliver 66& 70. OBO. 519-683-4672.

1951 FARMALL C ROW CROP, ready for restoration, runs excellent, OBO, \$1900. 905-797-2428.

MF 35 TRACTOR, gas, less than 1000hrs since new! exc orig cond, \$3995, OBO. 519-347-2451.

MF 165 TRACTOR, diesel, multi power, power steering, 3022 orig hrs since new! Professionally repainted, \$6500, OBO. 519-347-2451.

INT 3 FURROW PLOW, working cond, \$350. OBO. After 4 pm. working cond, \$350, OBO. After 4pm. 226-974-0936.



SIMPLE, EFFICIENT AND COST EFFECTIVE FLOOR AND SURFACE DRAINAGE SYSTEM

www.U-Drain.ca

- Factory constructed, bolt-together 9'10" (3 metre) sections
- Maintenance free, no grates to clean, remove or replace
- Open slot concept which blends in neatly with surface materials



PARKVIEW CONSTRUCTION | 519-755-8155 | u-drain@parkviewcm.com

1952 WILLYS ARMY JEEP, M38, 4 cylinder engine, 24V, 42000 miles, exc cond. 519-799-5701.

2- MH CUSHMANS, 4HP, gas, \$500 each or \$900 for pair. 519-345-2255.

1965 INT CUB CADET LAWN TRACTOR, restored, many options; creeper gear, rear PTO and more, \$1500. 519-345-2255.

SAWYER MASSEY, 20-22 steam traction engine orig double butt strap, riveted boiler, passed gmvt 4L thickness test, piping renewed w/ recusal 80, extra heavy pipe + fittings, cast iron grates, rubber on wheels, 20" rear wheels, exc cond, \$21000. 519-371-5903.

MODEL A FORD, 1931, deluxe roadster, all original, c/w resemble seat twin ride mounted spare wheels, c/w new 19" tires, plum maroon colour, black fenders, red wheel, new top, a beauty, exc cond. \$21000. 519-371-5903.

KIT CAR, Volkswagen engine, rep of 1928 Mercedes Benz, only 1579km, dash yellow, brown fender, with lovely pinstriping, raised rear bench back seat, bucket front seats, 6 bolt wheels, double chrome spokes, gauges to 130km/h, eng, RPM, oil temp & press, dynamo + petrol, radio + cassette player. \$8500. 519-371-5903.

2- JD 1954 4OU TRACTORS, serial #'s 2 & 3, to be sold as a pair, \$11000. Serial # research done by John Deere 2 Cylinder Club, US. 519-482-7115 After 6pm.

FARM ANTIQUES, engine seized with wagon cart, pair of wooden oxen wheels, implement steel wheel collection, hay mow carrier, hand forged ice tongs, all from a 7th generation farm. 613-929-4964.

MCCORMICK #6 MOWER, for parts. 519-369-6082.

1960 FARMALL 140 TRACTOR, built in cultivators, new rear tires, 12.4X24, 1 furrow plow & Powell 1R planter, exc cond, \$8000, OBO. 905-344-7304.

1956 800 FORD TRACTOR, 2 new rear tires/rims, new battery, hyd's, blade, cultivator, 2 furrow plow & 2 sections of harrows, \$4200. 519-786-5752.

35 YR COLLECTION ANTIQUE & FARM TRACTORS, most makes, all running, stored indoors, Niagara area. 905-682-6123.

JD 1010 TRACTOR, gas, \$2500, OBO. 613-756-2789.

JD #36 LOADER, good condition, Best Offer. 613-756-2789.

1940'S EBERSOL CROP SHREDDER, belt driven, del avail, serious inquiries only! Call or text. 705-328-8159.

MCCORMICK-DEERING HUSKER/SHREDDER, collectors item, del avail, serious inquiries only! Call or text, 705-328-8159.

INT DRAG PLOW, 3 furrow, works good, del avail, serious inquiries only! Call or text. 705-328-8159.

INT #10 SEED DRILL, trip lift, grass box, del avail, serious inquiries only! Call or text. 705-328-8159.

MANURE LOADER, for sale, 519-683-4672.

ALLIS CHALMERS B TRACTOR, 6' wide belly mounted mower, looks good & works good. \$3250 OBO. 519-296-4750.

1948 INT CUB, new tires, runs good, \$1850. 519-395-0980.

WINCHESTER RIFLE MODEL #94, lever action, hex barrel, canadian centennial edition, 1967, made in the USA, \$500. 519-395-0980.

1938 FARMALL F14, with factory hydraulics, 4 new rubber tires, in good running condition. 519-294-6441.

IH MCCORMICK PLOW, 3 furrow, fast hitch type, off Farmall 300, St Thomas area. \$400. 519-872-2188.

MCCORMICK-DEERING 10-20, working cond, \$3000, OBO. 519-881-0509.

PLOW cockshutt 3 furrow trail Ace Bottom plow. 519-525-0374

1949 DODGE DUMP TRUCK, 1.5 ton, dual wheel, flat head, 6 cyl engine with 4 spd trans, not running! 750.20 tires, stored inside since 1968, \$2200, OBO. 519-317-8508.

OLIVER 770 WHEATLAND TRACTOR, diesel, Hydra-Lectric, good tires, fender extensions, good cond, \$4900, OBO. 519-698-0081.

MH WOODEN WHEELED SEED DRILL, & scuffler. 519-665-2303.

KANGAROO WALKING PLOW, 2 furrow. 519-665-2303.

IH CORN SHELLER, for sale. 519-665-2303.

JD HORSE DRAWN RIDING PLOWS, & wood reaper. 519-665-2303.

BUILDINGS & STORAGE

BINS 1110

WOODEN BINS, 46"x52"x46" tall. 519-699-6013.

BUILDING SUPPLIES 1120



HEAVY DUTY LOADING RAMP 25' Ramp, 55" H x 103" W, \$5,000 O.B.O. WJ Heaslip (905) 779-3467.

AGRICULTURAL • COMMERCIAL • RESIDENTIAL

5" Seamless Steel and Aluminium Eavestrough Rugged steel eavestrough for todays metal roofing systems.

Siding • Soffit • Fascia • Steel Roofing

Riverside CONSTRUCTION

• GENERAL CONSTRUCTION
• AGRICULTURAL
• COMMERCIAL
• RESIDENTIAL

411575 Side Road 41, Mount Forest
Call: 519-323-9841

LEAKY ROOF?

Re-Ply™ it. Better than new. Guaranteed.

YOUR ASTEC® RE-PLY™ CERTIFIED CONTRACTOR

SAVE 50% & MORE

over replacement costs.

In Canada, Call:
1-866-896-1203

- ✓ Seamless, weathertight systems
- ✓ 300 million sq. ft. nationwide
- ✓ Top "Cool Roof" advantages
- ✓ 10-Year Renewable Warranty
- ✓ Free Roof Evaluations
- ✓ Protective Coatings for Roofs, Walls, Floors, Tanks and More.

ASTEC® Re-Ply™ Systems
manufactured by Insulating Coatings Corporation
www.icc-astec.com
www.nationalcoatings.ca
rbulley@nationalcoatings.ca

POWERLIFT

HYDRAULIC DOORS

The **SUPERIOR** quality hydraulic door... since 1992

Safe, Strong, Zero Maintenance!

We work with you every step of the way to build, deliver and install your new Powerlift door!

www.powerliftdoors.com

POWERLIFT DOORS OF ONTARIO
519-871-7368



P-TRAP FLOOR DRAINS

Removable insert for easy cleanout and sewer hose access. Available with plastic or metal drains.



SMALL P-TRAP DRAIN

Ideal for locations where less water runs through



BELL TRAPS

Available in heavy duty galvanized metal construction with stainless steel grate and bell or PVC with stainless steel grate and bell.



call Linside at 519-698-0472 for more details

STEEL STORAGE CONTAINERS RENT OR PURCHASE



LOW \$99/mth Rental Used Equipment

LOW \$129/mth Rental New Equipment

NEW OR USED

8 x 20ft Standard
8 x 40ft Standard
8 x 40ft High Cube

ALL UNITS ARE IN GREAT SHAPE
WITH HARDWOOD FLOORS, WIND AND
WATER TIGHT, CARGO WORTHY
CONTAINERS DELIVERY AVAILABLE!

container.depot2@gmail.com

1-800-256-2165

www.containerdepotexpress.com

FARM BUILDINGS & SHELTERS

1130

MOBILE HOME, 14' wide, 2 bedroom, great for farm help for offshore workers. 613-218-5070.

STORAGE & CONTAINERS

1140

ON FARM FUEL STORAGE TANKS

for flammable liquids, diesel fuel and gasoline



GPI PUMPS AVAILABLE UPON REQUEST

POWDER COATED & ALL SIZES IN STOCK. SPILL CONTAINMENT & ALL VENTS INCLUDED WITH PRICING.

670 L Single Wall
1350 L Single Wall
1350 L Double Wall
2200 L Single Wall
2200 L Double Wall
4500 L Single Wall
4500 L Double Wall

NEW 4500 LITERS UP TO 70,000 LITERS

Nithwood Enterprises Inc.

Nelson Martin | Wellesley, ON
519-656-3300

2 LG RECTANGULAR SS TANKS heavy duty, 14500 gallons each. 519-799-5701.

STORAGE TRAILERS, 43' or 53' for rent or sale. 519-323-1208.

FENCING & GATES

FENCING & GATES 1350

CEDAR POSTS, approx 60, \$7 each. 705-384-5505.

GATES, 1- 4x20 1" square tubing, 2- 4x10 1" square tubing, 3- 5x16' pressure treated 2x6, 1- 4x10' construction grade spruce 2x6. 519-683-4672.

6- BAR GALVANIZED GATES, 9-8', \$60 each. 1-12', \$75. 1-14', \$85. 519-451-1966.

CEDAR POSTS, 6"x8', 20 posts, \$8.50 per, After 4pm. 226-974-0936.

SPLIT CEDAR RAILS, approximately 80 in the pile, \$320. muldrewr@gmail.com.

CEDAR RAILS, 4' to 12' long, \$1 to \$4 depending on size. 519-501-2604.

GENERATORS, ENGINES & POWER SUPPLY

GENERATORS, ENGINES & POWER SUPPLY

1400

ENGINES, Yamaha, 5hp,\$100. Briggs& Stratton, 7hp,\$75. 519-506-3358.

WINPOWER GENERATOR, 20KW, PTO, including, heavy cord for a pull top switch, \$2500, OBO. 519-363-6016.

INT 466 DT ENGINE, 7.3 turbo diesel, with tans, low mileage. 519-758-4183.

HONDA RV 4010 GENERATOR, 75hrs, \$1500. 519-983-6848 or 519-983-6400.

HIGHLAND METAL PRODUCTS INC.

Residential, Agriculture, Commercial

Steel Roofing, Siding & Trims

5 profiles in 21 different colours

519-923-5846

Maxwell, ON

sales@highlandmetalproducts.com

www.highlandmetalproducts.com

NEW BARN BOARDS, white pine, 1x8, 1x10, 1x12, 12-16', .62-.74 cents/sq ft. Walter. 519-669-0345 or 519-669-2012.

LUMBER, Hemlock & Tamarak, Slab wood, custom log sawing. Mount Forest. 519-323-9647.

CHERRY LUMBER, approx 3000 board ft, 4 lifts of 1&1/4" and 3 lifts of 2&1/4". 519-799-5701.

LUMBER, 32pce, 6"x 14'x 1 1/2" plywood. \$5 each. 519-699-5399.

HW Howell Welding

100, 250, 300, 500, & 1000 GAL SINGLE AND DOUBLE WALL TANKS

METAL FABRICATING CUSTOM WORK PRAXAIR DEPOT



TANKS

Andy Howell
1-800-803-9450
519-627-5744
howell@kent.net
Wallaceburg, Ontario

POST YOUR FREE FARMER CLASSIFIED



T&T POWER GROUP

NEW AND USED GENERATORS
T&T POWER GROUP
www.ttpowergroup.com
 1-800-221-3432
 Wellesley, Ontario

Phase Converter & Transformer Sales
866-676-6686
INSTANT 3-PHASE POWER
From Your Single-Phase Line

- Simple Set-up
- Reliable 3-Phase Output
- Run All Types and Size Motors
- Agricultural and Industrial Duty
- Heavy Duty Start/Run Capacity

LOW INVESTMENT
SIMPLE SET-UP
HIGH RETURN

We Ship Nationwide

Phase Quest Converters Inc. offers a wide range of converters to accommodate all types of single and multiple loads indoors or out.



Phase Quest
 Generating Your Success

www.phase-quest.com

GAS GENERATOR, 9000W, 7000W continuous 110-220V, unit can be seen running on site, Alma. \$650. 519-638-2150.

20KW PTO GENERATOR, 540 RPM, on a 2 wheel trailer, 100AMP output, works well, Alma, \$1800. 519-638-2150.

62KW PTO GENERATOR, 1000PTO-RPM, on trailer, power cord, 200 plus amp output, like new, Alma, \$7300. 519-638-2150.

12000 WALLENSTEIN, like new, 20 hp Honda generator on wheels, about 50 hours on unit, multiple plugs, run your whole house. \$3500. 519-468-2025.

NJF MAGNATE MK II TRACTOR DRIVEN PTO AC GENERATOR, in perfect working cond, 25 kw, phase 1, 60 Hz, 104 Amps, 240/120 volts. \$2500. 519-870-2538.

400 AMP PULL TOP SWITCH, for sale, \$650. 519-468-2025.

ELECTRIC MOTORS, 2hp- 10hp, re-conditioned, single phase, exc cond. 519-889-0150.

NEW GENERATOR SETS
 Perkins Eng. / Stamford / MeccAlte Alternator. Call for Pricing.

PTO TRACTOR DRIVEN
 MeccAlte 30, 40, 55 kw. Call for other models and pricing.

60 KVA PERKINS/CAT
 Generator with new generator end. Multi voltage. \$7999.

CAT/PERKINS
 100 kw. 1104 TA with Dynagen Controls.

866-383-3641

LIVESTOCK/POULTRY/PETS

BEEF CATTLE 1610

BREEDER BULLS Black and Red Angus, Charolais. Top AI Bloodlines.. 705-266-4460. Cadillac Stock Farms bobperratt@ntl.sympatico.ca

FLECKVIEH FULL BLOOD SIMMENTAL BULLS, 2yrs old, ranch raised. 905-213-2612.

JERSEY BULL CALVES, starters, fully weaned, on full feed, 200+lbs, no hormones or antibiotics. 519-323-7781.

HOME RAISED BLACK ANGUS BULLS, ready to breed, ideal grass fed, mod framed, high marbling, very quiet. 705-652-1201.

PUREBRED RED ANGUS BULLS, 1 Yearling. 519-504-1086.

COMMERCIAL BLACK LIMOUSINE BULLS & HEIFERS, of breeding age. 519-670-2317.

BEEF CATTLE, speckle park cattle bulls for sale, extra edge, ready to breed. 519-521-8761.

PUREBRED HEIFORD BULLS, New Liskeard. 705-647-4848.

1 YEARLING HEIFER, open. 519-446-3682.

FLECKVIEH SIMMENTAL COW CALF PAIRS, mostly 1st calf heifers with crossbred bull calves, calves born Jan.15/16 and on. 613-628-2762.

ANGUS PAIRS, 1st& 2nd calf heifers, w/ April calves at side, ideal grass fed genetics, vaccinated. Heartwood Farms. 705-652-1201.

25 CHAROLAIS & CROSSBRED HEIFERS, approx 750lbs, 10 Charolais steer calves 650lbs, 10 black Angus Heifer calves 550-600lbs, all are vaccinated, lvomeced and ready for grass. 519-925-8502.

BEEF COWS, Black & Red Angus limo cross, cow calf pairs, \$3000 & up. 519-323-2145.

BLACK ANGUS BULL, 2yr old, registered & semen tested, quiet & ready to breed. 403-586-4851.

SIMMENTAL BULLS, solid black, polled, long yearling, semen tested, registered, docile, vaccinated, \$3500. 613-929-4964.

BREEDING BULLS STOCK, yearling& 2yr old, Simmental, Limousin & Red Angus. All performance qualified & calving ease. Also cow calf pairs, established high performance herd w/ full vaccination program. 705-745-8032, 705-927-2031.

14 REG RED POLLED CATTLE, and 1 bull. 519-363-6338 or 519-379-2036.

BEE ZEE ACRES LIMOUSINE CATTLE, selection of bulls- purebred, polled, red or black. Bill or Matt Zwambag. 519-494-9613.

BELGIAN BLUE BREEDER BULLS, Maple Haven. 519-423-6722, 519-421-4393.

BLACK ANGUS BULLS, exc pedigrees & carcass traits, performance & semen tested, del avail. Rob Roy Angus. 705-446-4740.

POLLED SIMMENTAL FLECKVIEH BULL, 2yr old, quiet, good feet & legs, easy calving family, del avail. \$3500. 416-464-2373.

BLACK 7/8 ANGUS, 1/8 MAIN BULL, 14 months old, easy calving, \$2600. 519-289-5660.

23 BLACK ANGUS HEIFERS, due soon, some with calves already. 519-294-6125.

DAIRY CATTLE 1620

FRESH HOLSTEINS, leucosis negative & vaccinated, good udders, feet & legs. Jersey's also avail. 519-292-9449.

HOLSTEIN SPRINGERS, grade and purebred heifers available at all times & fresh cows and heifers, Larry. 519-589-0191.

2 WATER BOWL VALVES, 3/4" inlet, 1 SM & 1 LG snout, new \$50. 1 Vink S5 double ratcheting new calf puller, \$300. 519-484-2633.

REG HOLSTEIN BULLS, service age, from high record dames. Del avail. McIntosh Holsteins. 519-475-4341.

NEW STICKY ROLL FLY TAPE, hardware kit, and 3 x1000' refills, \$150. 519-484-2633.

REG HOLSTEIN BULLS, service age, from high record dames, del avail. 519-535-4341.

HORSES**1630**

WESTERN WEAR, hats, shirts, boots & more, giftware, western art, wedding wear, show items, meds, tack shop, feed. Near Grand Bend. 519-294-0494.

APPALOOSA HORSES, ApHCC reg, lots of colour, some have been shown, owner retiring. Beautiful black Gelding, ages 5 years & up. Near Parkhill. 519-294-0494.

HORSE CART, 2 wheeled, like new. 519-723-4421.

2-DRAFT HORSE HARNESSSES, like new, and quantity collars. 519-723-4421.

CHROME NECK YOKE, never used. 519-227-4882.

ROPING SADDLE, Emor, nice tooling, exc shape, \$550. 519-395-0980.

SINGLE DRAFT HARNESS, nylon, c/w blind bridle, steel hames, slightly used, \$450. 519-395-0980.

6REG SUFFOLK PUNCH HORSES, for sale. 519-363-6338 or 519-367-2036.

BLACK & WHITE PAINT PERCHERON CROSS DRAFT, 4 yrs old, mare, very quiet, 16H. 705-877-2949.

2 SETS OF HEAVY SHOW HARNESS, with chrome and bonnies, reasonably priced. 613-258-3561.

PERCHERON DAPPLE MARE, 6yr old, 17.3 hands high, 1800lbs, well broke 3 ways, quiet. South Mountain. 613-989-5450.

BARONIAL MORGAN, anual fall reduction sale, champion blood lines, champion produce, 30+ under 3yrs old, Bays and Chestnutt, most registered, some started. 905-355-2689.

WHITE HORSE MACHINE, forcart, new, c/w adjustable pull and shafts, c/w with steering and tortion axles. \$1550. 519-395-0980.

SHOW HARNESS FOR DRAFT HORSES. BLACK LEATHER, STAINLESS STEEL HARDWARE, WITH HARNESS BOXES, \$5000 OBO. 519-674-0278.

LIVESTOCK EQUIPMENT**1640**

WATER FLOAT, stainless steel, double sided. 519-699-9409.

L.B. WHITE BOX HEATER, Guardian 100000BTU, \$400. 519-458-8850.

HEAD RAIL, 24.5' long, used for silage on pit wall, \$400. 519-376-9359.

MILK MIXER, flex augers 350, 170-galv. stalls, feed bins, collars, chains & snaps, Patz gutter cleaner. After 1pm. 519-670-4552.

SHURE SHOT ELECTRIC PROD, w/ charger, extra battery, used little. 519-338-3268.

GOAT MILKING EQUIPMENT, stands for 16 goats; milk equipment for 8, 600gal cooler, new compressor; pump, vacuum and all washing equipment, portable vacuum with 4 cans. 416-455-2900.

CALF MILK FEEDER, warm box, \$500. 519-356-2213.

TIP TROUGH, 8' Stainless Steel, \$200. 519-356-2213.

SCORPION ELECTRIC FENCER, very little use. 519-338-3268.

CACKELLAC SHELTERS, raise your own chickens outdoors on pasture. 519-501-2604.

DELAVAL AUTOMATIC RAIL CART FEEDER, brand new charger, exc cond, rail system also avail. 613-551-0754.

STABLE CLEANER, Houle chain, 280', hook & eye, reg 18" RH, Beatty stable cleaner drive oil bath, green unit, loaded reverse bend/reverse bend, crystal spring wet/dry feeders dble 2&3 hole, Farmatic push augers & drives, 3&2 tonne feed tanks, cyclone & valves, shedded & above avg cond. 519-527-1482.

6 CRYSTAL SPRINGS HOG FEEDERS, single space, \$300 each. 519-320-8768.

SCREEN CALF PENS, with winch system, for 160 calves, c/w pails & holders. \$7000. 519-550-6759.

6 DELVAL MILKMASTER MIXER, pulsation & wash controls. 519-292-9449. ebybrook@hotmail.com

HOOF TRIMMING CRATES, for sale. 519-348-9620.

CATTLE SQUEEZE SHOOT, good cond, \$750. 613-256-3067.

PLASTIC/ FIBERGLASS T, pig flooring. 613-378-2255.

CATTLE FEEDER, 4x12' wooden with rood, for small square bales, on oak skids, OBO. 519-683-4672.

DOUBLE 7 DELAVAL HERRINGBONE PARLOUR, new meters in 2007, well maintained, exc cond, c/w 250 ID tags, 2 cooling units, heat recovery tank, 10hp vacuum pump, variable spd milk pump. ready to milk. \$25000. 519-636-7132.

HANGING DOUBLE NIPPLE S.S DRINKERS, like new, exc cond. 519-348-8170.

HIGH/ LOW CANARM HEAT LAMP, 20 units. 519-348-8170.

HAGEDORN CATTLE SQUEEZE CRATE, fold down sides, auto headgate. 519-799-5701.

CALF PULLER, two heads, like new. 519-799-5701.

4 BOUMATIC MILKERS, with auto take offs. 905-648-3169.

3PTH, gate to lead cattle. 519-376-9359.

CATTLE EQUIPMENT, cattle gates, wood cattle feeder. 519-683-4672.

PIONEER FORECART, 2 seats, rubber tires, brakes, pole and shaves, Ridgetown, \$1000, OBO. 519-674-0278, mcdaleclyde@gmail.com

HORSE DRAWN BOB SLEIGH, w/ bench seats, exc cond, stored inside, pictures avail, \$1000, OBO. Ridgetown. 519-674-0278.

HOOF TRIMMING TIP TABLE, hyd, workable cond, commerial use, \$900. 613-659-2798 or 613-659-2791.

CATTLE SHOOT, for calves, \$50. 519-934-2722.

FIBERGLASS FEED TANK, for cattle, 2.8 tonnes in size, always stored inside. 905-648-3169.

URBAN MILK MIXER, 300L, \$900. 519-550-6759.

WEIGHTRONIX SCALE c/w 4 S type 1000 lb load cells, \$1150. 519-846-2312.

POULTRY**1660**

Bonnie's
Chick Hatchery Ltd.

A family owned business since 1941

HATCHING WEEKLY

Brown & White Egg Layers
Ready to Lay Pullets
Meat Varieties
Turkeys

18 ARTHUR STREET N., ELMIRA
519-669-2561

GRASS FED POULTRY, butchered chickens avail to order before Aug 18th. Order your Thanksgiving turkeys before Oct 6th. Moorefield. 519-638-0440.

55 AMERAUCANAS EASTER EGG CHICKS, 3 weeks old, rooster on sight. 613-850-0052.

SHEEP & GOATS**1670**

PUREBRED ALPINE & SAANEN BUCKS, from herd on official milk test, doelings also for sale occasionally. silver crown dairy goats. 519-923-5784.

SHEEP/GOAT/PIG EAR TAGS 125 green tags, Flex Lok, 50 Yellow (25 Allflex/25 Flex Lok), 75 Orange Flex Lok, 25 Yellow Allflex, 100 Red - med Allflex, 1 Allflex Total tager tool, \$300 for all! 519-484-2633.

YOUNG RIDEAU EWES & RAMS, vaccinated guaranteed, closed herd, Levi Bauman. 519-501-7191.

RIDEAU ARCOTT, ewe lambs & rams/ram lambs. 519-617-1267.

REGISTERED COMMERCIAL BOER BUCKLINGS, CAE negative tested herd. Reserve now! 519-940-8897 or www.naquabiboergoats.com

BREEDING BUCKS, Saamen & Alpine. 519-708-8588.

ILE DE FRANCE YEARLING RAM LAMBS, ready to work, great out of season breeding. 519-802-6411.

CUSTOM SHEEP SHEERING, Goats or sheep, hoof trimming, will travel. Milverton. Call John, 905-749-8188.

COMERCIAL BILLY BUCK, 75% Kiko, 25% Boer, 4 months old, exc breeding stock, fast growing, hardy parasite resistant. 705-724-2676.

SOUTHDOWN SHEEP, ewes, rams, club lambs & seed stock. Del avail. McBrien Livestock. 519-437-1874.

30 YOUNG BOER GOAT DOELINGS, CAE negative. 519-788-1344.

30 BRED DOES, due end of June. will be their second lactation. cell 613-298-3644 or 613-524-3005.

PETS 1685

SIBERIAN HUSKY DOGS & YOUNG ADULTS, CKC reg'd, vaccinated, sires & dams on site, micro-chipped, colour choices, gentle temperament. Boarding all breeds; dogs & cats. We do not sell to puppy mills. Parkhill. 519-294-0494.

M&M LIVESTOCK, buyers culled cows & old horses. 705-878-5463, 905-852-3238, 519-836-2070.

OTHER 1690

RANCHERS HANDBOOK & CHINCHILLA TRAY steel, hardcover, 8 trays 18"x15"x2.5, 32 auto sanders, 19 trays 24"x14.75"x 2.75". 519-376-9359.

SHEEP SHEARING & WORK, also llamas & alpaca's, off the grid services avail, Jacob & Samuel Sloan, no Sunday calls. 519-363-5564.

VENISON, whole carcass, \$3.95lbs + processing. 519-289-5968.

RED DEER, 25 hinds & 1 stag, retiring will negotiate price, avail. in September due to fawns. 519-289-5968.

6' MANURE BUCKET, for tractor or skid steer, good cond, tines are 28" long, \$250. OBO. 519-482-7115.

15MO MINATURE JACK DONKEY, raised with sheep. \$350. 519-524-9824.

MISCELLANEOUS PRODUCTS

ENERGY PRODUCTS 2020

12V HYDRAULIC POWER PACK, \$250, OBO. 519-338-2691.

HEATING & FIREWOOD 2040

2 PROPANE HEATERS & REGULATORS, 100 gallons, \$100 each for heaters & \$100 each for regulators. Ancaster. 905-648-3793.

1992 SWEETHEART WOOD COOK STOVE, made by Heartland appliances, rare white, exc cond. 705-844-1493.

CLARE JEWEL WOOD STOVE, warming oven above, good shape. 519-348-8170.

FIREWOOD, hardwood, del to door, \$85 cord. 519-363-2386.

GAS HEATERS OR SALE, 1 for shop hang up, 1 for the cottage. 519-475-4772.

1 COCKSHUTT CULTIVATOR, pull type. 519-475-4772.

HEARTLAND OVAL WOOD COOK STOVE, exc cond, New Liskeard. \$3200. 705-647-4848.

HERITAGE WOOD STOVE, works great, \$450. 905-537-6977.

CLARE HECLA WOOD FURNACE, working cond. 519-698-2098.

NEW R10 INSULATION PANELS, for radiant floor heat. 519-575-3605.

MISCELLANEOUS PRODUCTS

OTHER 2090

500 GALLON WATER TANK, \$125 226-271-5391 or 519-866-3315.

225 GALLON FUEL TANK, no pump. \$100. 226-271-5391 or 519-866-3315.

225 GALLON FUEL TANK, with pump, electric. \$250. 226-271-5391 or 519-866-3315.

HARVESTORE SILO SHEETS, 24; 4.5'x9'; \$100persheet, \$450brandnew. 519-365-5725.

MOTOROLA FM 2 WAY RADIO SYSTEM, base with 3 portables. BO. 905-541-4427.

BLACK TOBACCO TRAILERS, 6 pair in average cond. 519-358-6405.

DAYTON MONEY WEIGHT SCALE 25lb counter top scale, \$150. 519-484-2633.

VINYL SIDE SLIDER IN STOCK

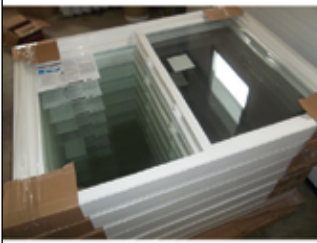

thermal, low E with screen
42x30 \$135 | 48x36 \$149
Jmould + \$20

DURALITE WINDOWS
519-595-7334

WOODEN PLYWOOD BOXES, half bushel size, rectangular shape, stackable & solid, 16"x14"x6". 519-683-2777.

4 WHEELED CARRIAGE, single chase for mini or sheltand horse, \$650. 519-786-4372.

1 STAINLESS STEEL MILK TANK, 300 Gallon, Suitable for water or syrup. 905-648-3169.

25 COLOURED SIDE WALK CONCRETE SLABS, \$2.50 each. 519-462-2650.

PLASTIC TANK, 65"x40"x20" deep. 519-338-3268.

MASQUITO MAGNET, propane powered mosquito trap, \$200. 519-484-2633.

GOLF CARTS, electric and gas powered, E-Z-GO and Club car, for parts only, \$299 each. 519-758-4183.

CLUB CAR, gas, both have good tires & need TLC, \$299 each. 519-758-4183.

ROXTON, solid oak hutch & buffet, 53"x78"x16"D, corner curio & wall curio to match with lights, like new, sylvet for country living, reasonably priced. 519-294-0494.

PLASTIC TANK, 1000 gallons, on steel frame, off large cultivator, \$1000. 519-941-0738.

FREE, 15, Precast concrete rapidex slabs, 8" thick x 46.5" wide x 46" long. 519-575-1937.

LIMESTONE, small to 5-ton. 519-534-1997.

BEACHCOMBER HOTTUB 6 person hottub with cover \$2500 ljlwilkins@hurontel.on.ca 519-529-3698

FRIDGE WITH FREEZER ON TOP, white, full size, 3"x 3" black mark, works, is loud, \$100. 519-765-1691.

GENERAL ELECTRIC TWO WAY RADIOS, 4 mobile and 1 base. B.O. 519-524-1139.

WATER TANK, 4' x 12', steel, \$500.
519-723-1126.

SEED/FEED/CROPS

HAY

3530

NEW GRASS HAY, 175-6' bales, stored inside, exc quality. 519-901-0787.

TOP QUALITY HAY & STRAW, low potassium, all prices quoted, delivered, Paul @ Deer Run Farms. 519-848-3442.

TOP QUALITY HAY, dairy, horse and goat hay & straw, lg sq bales, 1st& 2nd cut hay, no rain. Del avail. in 30 bale loads. 416-464-2373.

SQUARE BALES OF HAY, 1st & 2nd cut, stored inside, dry. 519-934-2608.

ROUND HORSE HAY, hardcore, dry, stored inside, exc quality, \$45/bale. 519-934-2608.

SECOND CUT ALFALFA, lg sq bales, 80/20 mix, no rain, stored inside. 519-449-2690.

STRAW, smsq bales. Denfield. 519-670-2317.

HAY FOR SALE, big sq bales 3x3x7.5 alfalfa timothy first cut & first cut grass. Oat straw & oats, smsq bales. 519-847-5797.

HAY, big round bales, sold & del by the pound. Call Crawford Farm, Glencoe. 519-871-3423.

GRASS HAY 5x5 lg round bales, 1400lb each, 1st & 2nd cut, exc horse quality, stored inside, \$100/bale. 519-380-5599.

STRAW & HAY, 3'x3'x6' lg bales' with acid. del available. Thamesford. 519-878-5124.

SMALL SQ BALES, grassy alfalfa, horse quality, 1st & 2nd cut. Earl Morwood. 519-847-5715.

HAY, bg sq bales, wrapped, first cut. 519-757-5708.

HAY, sm sq bales, 1st cut. 519-752-1376.

5X4 ROUND BALES, 1st & 2nd cut grass hay, exc. quality, stored inside, large round and small squares of straw. 905-308-1351.

STRAW, lg sq bales, 08 cents/lb, Kevin. 519-274-2550.

1ST CUT HAY, lg sq bales, 80/20 mix. 519-449-2690.

SM SQ BALES OF HAY, 1st cut. 519-670-2317.

HAY, 2016 - lg round sq bales, 4 1/2' diameter, 1st cut - most grass and alfalfa, 2nd cut - 4' lg round bales, 2015, Chatham area. 519-674-2629.

CERTIFIED ORGANIC STRAW/HAY lg sq, no rain. 519-569-1779.

HAY, 2016, 4x5's, good quality, stored inside. 519-847-5715.

SEEDS

3540

BUCKWHEAT SEED, for sale, \$30 50lb bag. 519-375-0636.

CERTIFIED ORGANIC RYE SEED, as well as mixes for cover crop or plow down. 519-569-1779.

STRAW & BEDDING

3550

BIG SQ BARLEY STRAW, 3'x3'x7', stored outside under tarp. 705-305-7159.

STRAW, dry, good quality, \$3.50/bale. 519-934-2608.

WHEAT STRAW, 3'x3'x7' bales, stored inside, approx 500lbs, \$45/bale. 519-525-2219.

OAT STRAW, sml sq, 1200 bales, 2015 crop, clean, \$3/bale. Union. 226-378-0317.

STRAW, 4x5 rounds, oats & wheat, also corn stock straw. No Sunday calls. 519-616-4985, 519-848-5916.

GOOD QUALITY STRAW, 4x5 rounds. 519-847-5715.

OAT STRAW, big sq bales, \$45 for 3x4x7 bale, stored inside. Markdale. 519-503-1101.

WHEAT STRAW, feed quality, rotary combine, 3x3x7 big squares or 4x5 net wrapped round bales. 519-881-8966.

LONG STRAW, 3000 sm sq, del avail. 905-687-0046.

CLEAN STRAW, 3x3x6', stored inside, will deliver, Thamesford Area. 519-808-9672.

STRAW, round & big sq, sold & del by the pound. Call Crawford Farm, Glencoe. 519-871-3423.

STRAW, big sq bales, stored inside, \$40 each. Haldimand County. 905-299-9313.

3X3X7 SQUARE BALES, clean wheat straw, \$40/bale. 613-922-2915.

LARGE 3X3X7 OAT & WHEAT STRAW, from rotary combine, del avail, custom baling services avail. 519-525-8523.

STRAW, 3x3x6.5, stored inside, \$40 per bale. 519-462-2650.

WHEAT STRAW, clean & dry, stored inside, 3x3x7 & 3x3x8, Picton. 613-968-0096.

OTHER

3590

HAY & STRAW, sm & big sq, various mixtures, del avail. 519-617-1267.

WHEAT STRAW BALES, 300-4x5 net wrapped, stored indoors. Binbrook area. 905-518-3868.

WHEAT STRAW, nice, clean, rotary combined, good for TMR. 3x3x7' bales, \$42-FOB. Huron East. 519-292-0138.

82 ACRES WHEAT STRAW, by the lb, off field 50% performance deposit required. 519-799-5701.

KONGSKILDE DP40, rotary screen cleaner with aspirator. \$3900 OBO. 519-524-0107.

SERVICES & CONTRACTING

CONSTRUCTION & DEMOLITION

4020



S&J
BARN DEMOLITION

We pay cash to remove your old barn and/or log cabin - call us today for a free estimate. Fully insured and complete clean up available.

705-526-9595
1-800-291-BARN
canadianantiquelumber.ca

CUSTOM SERVICES

4040



RIVERSIDE EQUIPMENT
repair & manufacturing

- WELDING • MACHINING
- BUILDING OF CUSTOM EQUIPMENT
- GENERAL REPAIRS
- SHEARING AND BRAKING

Custom Built Silage & Grain Dump Wagons & Trailers

R.R.#1, Mount Forest, ON N0G 2L0
519-323-4170

FREE FARM CLASSIFIED

ATTACHMENTS

ATTACHMENTS 5000



PALLET FORKS
42" - \$555, 48" - \$695

HILL HYD BIN DUMPER, \$2000
905-531-9819.

LOAD MONITOR CYLINDER, for plow, older model series 7710 or 8210 Ford tractors. 519-369-2262.

SADDLE TANKS, \$1500, OBO. 519-529-7765.

V-DITCHER, 3pth. \$250. 519-791-2163 or (519-326-1262 evenings).

PTO SLIP CLUTCH ADAPTER, 540RPM, shaft, in/out, rated at 8000lbs, new! \$200. 519-484-2633.

FRONT 3PTH, off a JD 5420, complete. 519-827-0343.

LEVCO ROTARY DITCHER, PTO. 519-977-3335.

ROUND BALE FORK, heavyduty, slides under the bale, rear mount 2 pth, excellent condition manyother uses as well carrying logs etc. can text a picture \$350 muldrewr@gmail.com

FRONT BLADE ATTACHMENT, fits IH A-140, \$100. 519-484-2807.

2015 HORST ROCK FORK, 84", \$800. 905-687-0365.

CHEMICAL/FERTILIZER APPLICATORS

FERTILIZER APPLICATORS - DRY 5120

3PTH LELY CYCLONE SPREADER, for sale. 905-230-0838.

VICON FERTILIZER SPREADER, s/s spouts, 5" spout, part # 79760043, 7" spout part # 79760046, 12" spout part # 79760044, \$200 each. 519-484-2633.

HERD PT750 FERT SPREADER, \$650 905-643-1402.

FERTILIZER APPLICATORS - LIQUID 5130

DEMCO SADDLE TANKS, 200 gal each, mounting brackets to fit 8900 series Magnum tractors, used 2 years, \$2400. 519-291-0147.

HARDI SPRAYER, 500 gallon, 42' boom, foam markers, works good, \$3500. 905-687-0046.

SPRAYERS - 3PT /MOUNTED 5150



CALSA SPRAYER TANK 100 gal, 3ph, PTO pump, hand gun, for fence line sprayer. \$450. Dan Seifried, Harriston. 519-338-2688.

HARDI VINEYARD SPRAYER, 3pth, Zenit, 130 gallon, 2R, 2spd air blast, axial flow fan, leveling boom, used 1 season, exc cond. St. Thomas. \$900. 905-473-9536.

SPRAYER BOOM, 3pth, 90', Fast Model 963P, 3 sectional w/ 15" nozzle bodies, Norac auto boom height control, hyd pump avail, \$12000. 519-674-0054.

SPRAYERS - PULL TYPE 5160

CONTINENTAL FIELD SPRAYER, for sale. 905-230-0838.

JOHN BEAN SPRAYER, 60' hydraulic boom, 500 gal, \$1900. 519-662-1855.

AGRI TREND SPRAYER, 45', 500 gallon, GPS speed sensor, TeeJet rate controller. 519-502-3291.

DEMCO SPRAYER, 45' boom, 500 gal. 519-424-9240.

HARDI TR500 FIELD SPRAYER 50' manual fold boom, triplet nozzle bodies, 3 tips, chem fill, top drain, 2" quick coupler fill, elec controls, lg 361 pump, exc cond. 519-639-4406.

HARDI 500 GALLON SPRAYER, 45' manual fold, self leveling, hyd lift boom, elec controls, tandem axle sprayer. Also sold separate, Hardi foam markers. 519-849-5428.

WHITE PULL TYPE SPRAYER, 200 gallons, for field or orchard, new pump. 905-643-2423.

FMC 400G SPRAYER, FMC 400G SPRAYER, 65' boom, \$1000. 519-358-6405.

400 GALLON ALUMINUM TANK SPRAYER, George White, tandem axle, 40' boom, \$475. 519-354-9584.

AG SYSTEMS 6000 SIDE DRESSER, 12R, 710 gallon tank. 519-807-7903.

SPRAYERS - SELF PROPELLED 5170

3 WHEELED DELHI SPRAYER, self propelled, needs work, \$600. 519-327-4480.

JD 4930 SPRAYER, 120' boom, 20" spacing, 5 sensor Boom Trac, high flow, 5 nozzle bodies, hi flow pump, foam marker, chem inductor/load control, HID lights, wheel motor shields, hyd tread adj, 380/105R50 Firestone tires, 75% traction control, 2600 display, 4000hrs. 519-475-4482.

JD 6000 SELF PROPELLED SPRAYER, 60' hyd fold boom, Raven SCS 440 rate controller, foam markers, exc cond. 519-323-3977.

OTHER 5190



CIH 2300 CONCORD 4 Wheel Air Cart, Split Tank, 138/92 Bushel, Hyd. Drive Fill Auger \$9500. Dougherty & Williamson (519) 587-2273.

Brubacher Drums

PLASTIC & STEEL DRUMS AVAILABLE.

1000 ltr totes **\$120 ea.**

Good non-food **\$100 ea.**

855 Arthur St. S., Elmira
519-664-2958

PAIR DEMCO 200 GAL SADDLE TANKS, mounting brackets, fits 8000 Series - MFWD, JD, \$2500. 519-617-6439.

CASOTTI GINSENG SPRAYER HEAD, super 12V, \$500. 519-484-2633.

TURNCO 300 GALLON SADDLE TANKS, frame and tanks, no pump or plumbing, best offer. 519-643-8099.

COMPLETE LIQUID, Fertilizer system for up to 30 ft. air drill. No Sunday calls. 905-701-1605.

FERTILIZER TRUCK MOUNT AUGER, for sale. 519-942-7159.

FERTILIZER TENDER, on 98 Sterling truck, Rayman box with side shooter auger and belt centre feed, \$20000. 519-524-0107.

52' SPRAYER BOOM, \$600 519-327-4480.

1975 FMC BEAN SPRAYER M577CT 345 IHV8, set for 3 hectare, 400 gal of water. 905-689-4931.

1988 FMC ORCHARD SPRAYER #587, CPD, Durand Whaler Smart Spray System, 4 cyl Cummins diesel, fiberglass tank, set for 3 hectare, 400 gal of water. 905-689-4931.

CONSTRUCTION & INDUSTRIAL EQUIPMENT

BACKHOES & LOADERS 5210



JOHN DEERE 410B BACKHOE good condition, new tires. \$16,600. Howe's Farm Equipment 613-678-5599.

SHAWNEE LOADER will fit 1953 Ford and up, 5 1/2' hyd bucket, call after 6pm. \$400. 905-939-9076.

MF 60 LOADER EXTEND-A-HOE 30" & 12" buckets, good tires, 700hrs on motor overhaul. \$10000. 519-293-3420.

1990 JD 624E LOADER, 4WD, quick attach 3yd bucket & fork assembly, 9900 actual hrs, well maintained, \$38000. 519-765-2064.

BLADES/SCRAPERS 5220

SCRAPER BLADE, 7', brand new. \$400. 519-699-5399.

SCRAPER BLADE, 6', 3PTH, exc shape, \$350. 519-395-0980

7' SCRAPER BLADE, heavy duty, \$200. 705-384-5505.

DOZERS 5230

JD 420 CRAWLER, with loader & bucket. 519-665-2303 bosomworth@wightman.ca

2 JD 420 DOZERS, 1 w/ loader + large bucket, 1 w/ front blade + rear backhoe, c/w narrow bracket & wider one, \$4000 & \$6000. 519-371-5903.

TD9 BULLDOZER, w/ grubber blade, 1948, \$4000. 519-534-1997.

JD 1010 DOZER, needs motor, \$2500, OBO. 613-756-2789.

EXCAVATORS 5240

1987 CAT 215 DELIMBER, rebuilt motor, both hyd pumps, chains, sprockets, pads w/ice picks, trade for logging forwarder or \$25000. 705-662-0483.

KUBOTA KX057-4 2013, 970HRS,a/c, heat,radio,hyd thumb,new bucket. \$63500 Callaghan Farm Supply Lindsay 705-324-8686

FORKLIFTS 5250

INDUSTRIAL FORKLIFT, heavy outdoor tires, good running order. 519-697-2703.

WALDON 5000 FORKLIFT, diesel, 4WD, articulated, high/low range hydrostatic trans, solid rubber tires, \$5500. Sudbury. After 7pm. 705-662-0483.

ALUMINUM PROPANE FORKLIFT TANK, 200 519-484-2633.

WIFO 3 PTH FORK LIFT, 3500 lb. capacity, \$1000. 905-531-9819.

Used Forklift, \$2,000. North Wellington, Arthur 519-848-3504.

Used Mast, \$500. North Wellington, Arthur 519-848-3504.

Rental Units 3000lbs to 15000lbs. North Wellington, Arthur 519-848-3504

GRADERS 5260

SAWYER MASSEY RD GRATER, 8ft grater blade, weighs 5000lbs. 519-369-6082.

ROAD GRADER, 4 wheel tractor pulled. 905-939-2976.

OTHER 5290

3PTH CEMENT MIXER, for sale. 905-230-0838.

UNIVERSAL LAND RAKE, 4 land clearing, 12'; was on bull dozer. Sudbury. 705-662-0483 After 6pm.

JD CHERRY PICKER, to load logs on trucks,\$2500. 613-735-6602.

CEMENT BLOCKS, 8" and 10", 200-300, BEST OFFER. 519-363-6338.

APPROX 1000 CEMENT BLOCKS Make an offer! 519-482-7901.

OVERHEAD SHOP CRANE, 4-ton capacity, rolling trolleys, \$2500 OBO. 905-537-6977.

FORESTRY & WOODLOT

CHIPPERS/SPLITTERS 5310

WOOD SPLITTER CYLINDER, 4" barrel, \$50. 519-356-2213.

MILLWOOD PTO BUZZ SAW, 3pth, used very little, \$799. 519-758-4183.

WOOD SPLITTER, on trailer, with single cyl engine, \$400. 519-371-5903.

OTHER 5390



Test our pre-production and prototype models for deep discounts by giving us all the necessary feedback to make sure these models meet the requirements demanded in the field. No Warranty can be provided on labour but you'll receive deep discounts through our dealer network & 1 year warranty on parts only. Conditions apply call for details. See website for details www.baumalight.com



HOULE TS-16 TREEREX TREE SHEARS Up to 16" Cut Capacity, Rotates 110 Degrees, Currently Manitou QA Mounting, Loader or Skid Steer Mount, \$8995. (519) 587-2273.

FULL SAWMILL, produces 20000' a day, over \$70000 spent on new band saws. 613-735-6602.

TREE TOPS, lot has been logged, only tree tops left, you cut, good for firewood. 905-648-3793.

TREE FARMER C6D SKIDDER, long frame, good tires & 4 chains, gear-o-matic, 20 winch, GM diesel, runs & works good, \$15000. Sudbury. 705-662-0483 After 6pm.

SKIDDER WINCH, 20 gear-o-matic with main line, from C6 tree farmer, \$1500. 705-662-0483 After 6pm.

TREE FARMER SKIDDER C5D, new front tires, 4 tire chains, detroit diesel, 1 owner machine. \$12000. Sudbury. After 7pm. 705-662-0483.

COMPLETE SAW MILL, circular saw, auto carriage, bull edger, 5 band re-saw,\$100000. 613-735-6602.

DANKART LUMBER PLANER, sitting on a float. \$6000. 613-735-6602.

CUSTOM FIREWOOD PROCESSING, hardwood fire wood, del available, contact Keith. 519-595-4010.

LUMBER, Hemlock & Tamarak, Slab wood, custom log sawing. Mount Forest. 519-323-9647.

SKIDDER TREE FARMER C4, 4cyl gas, 2 new rear tires, great little machine, \$11500. Kingston Area. 613-387-3895.

LINDEN TREES, 14', 3" trunks or better, selling in groups of 4 or 8 total. 519-323-1208.

SINGLE PHASE JET PLAINER, 5HP motor, variable speed feed intake, good cond. 519-323-4796.

28" PLANER 28" Planer with spare blades, heavy duty, 10HP, 220V, very good cond. 905-768-0056. normanfarms@optionsdsl.ca

FIREWOOD ELEVATOR, 18" x 33', rubber belt, hyd. drive, 1 year old, good cond, Steven, leave message. 519-595-7035.

GRAIN HANDLING / STORAGE

AUGERS / ELEVATORS / CONVEYORS

5410

CONVEYOR-ALL BELT, 50', PTO, gas engine, \$2900. 519-365-5725.

VERSATILE AUGER, 40', 16HP Briggs & Stratton engine, electric start button, \$375, OBO. 519-969-1542.

WESTFIELD AUGER, 41', PTO. \$1200. 905-263-2060.

FARM KING AUGER, 8"x41', exc cond, \$1850. 519-692-4758.

WESTFIELD 741 AUGER, brand new. 519-695-6613.

WESTFIELD 851 AUGER, electric drive. 519-695-6613.

LITTLE GIANT COMBINATION ELEVATOR, for sale. 905-563-7389.

BRANDT GRAIN AUGER, 7x41, wind damaged, BO 905-376-0281.

AUGER, 12' hyd fertilizer/seed, \$800. 905-376-0281.

3 VALMETAL BELT CONVEYORS very good shape. 519-757-5708.

GRAIN FERTILIZER AUGER, Hyd, 6" for a wagon, very good condition. \$500. 519-538-2268.

2 - GRAIN AUGERS, One, like new, never used, both 4", 16', \$300 each, with motors. 519-538-2268.

LITTLE GIANT BALE ELEVATOR, 32'. 519-527-1482.

SINGLE CHAIN ELEVATOR, Corn or grain, aluminum chassis, 5hp Kohler engine, \$250. 519-354-9584. After 6pm.

GRAIN AUGER, 30"x8". \$1500. 519-791-2163 or (519-326-1262 evenings).

FEED TRUCK CYCLONE, Call for specs. 519-799-5701.

SKELETON HAY ELEVATOR, 50', transportation wheels & motor, \$1500. 519-786-4372.

30' PIPE BALE ELEVATOR, with motor, \$200. 519-374-1048.

WESTFIELD AUGER, for sale. 905-870-7936.

PATZ OVERHEAD BELT FEEDER, 40', 2yrs old, 2000 60 hd freestalls boumatic double 4 palour pump 10 hp, cooler etc. 519-501-2694.

WESTFIELD AUGER, 10X71 hyd. lift, \$4000. Peterborough area. 705-745-7088.

20' CLAY SILO UNLOADER, w/ Butler winch, Parts machine or rebuild project, \$500. 519-590-0236.

42" AIR STREAM, 10hp single phase for a grain dryer, all controls, 3yrs old, bought continuous flow. 519-692-3675 or 519-360-0325.

SPEED KING GRAIN AUGER, 43"x6", 3hp electric motor included, good condition. 519-347-2451.

MARKET PLASTIC TUBE AUGER, 12', hardware mount for grain wagon, like new, \$1200, OBO. 519-770-7551.

WESTFIELD AUGER, 71', swing arm, \$7900 905-687-0365.

REBUILT UNLOADING AUGER, gear box, for MF combine, fits 410-550 models, new gears & bearings, \$300, OBO. 519-347-2451.

FARM KING 360 ROTARY GRAIN CLEANER, 6" feed auger, exc cond, \$2500, OBO. 519-698-0081.

HUTCHINSON ROOF GRAIN AUGER, 6"- 62' long, 3 outlets, always shedded, mounts on roof trusses, used for storing grains, \$450. 705-435-9163.

115' VALMETAL 14" BELT CONVEYOR, motor, wiring, switch, elbow, left/right plow, disassembled, inside, \$1500. 613-850-0052.

GRAIN AUGERS, 4" & 6". 519-665-2303.

2 HEAVY DUTY galvanized belt conveyors 20"x29" and 20"x32' \$2600 ea. 519-846-2312.

GRAIN BINS & EQUIPMENT

5420



BRUNS 400 BUSHEL on 205 horst 20" extensions \$4595. Profota's Farm Equipment 519-354-5100.



DRINCK 400 BUSHEL grain box on horst running gear \$4300. Profota's Farm Equipment 519-354-5100.

2 VERTICAL HOPPER FEED BINS, 12 Ton is \$2500, 6 Ton is \$1000, both exc cond. 905-376-0281.

GRAIN BINS, 3-5000 bushel Westeel Rosco 19' \$2000. 3- full floor aeration 19' \$ 2200. 2- 14' Grain bins. 1- 12500 Grain bin \$9500. 519-338-3920. No Sunday calls.

3-WESTEEL GRAIN BIN SHEETS, 18', \$25 each. 519-462-2650.

KONGSKILDE 1000 SUCKER BLOWER, stored inside, good cond. 519-271-9228.

21' STEEL SILO, with hood, \$200. 519-374-1048.

JD MODEL B GRAIN DRILL, grain only, 16R, hyd lift installed, 2 trips available. \$975. 519-683-4672.

GRAIN BINS, 2000-30000 bu. , some with new aeration floors. 705-799-7262.

12,000 BUSHEL BINS, c/w new aeration floor and new U-trough. 705-799-7262.

BEHLEN GRAIN BINS, 2-1100 bushel, with fans, need to be disassembled. 519-846-5063.

GRAIN BIN FLOOR, with supports, 27" diameter, c/w unload auger & motor. 519-674-2724.

8" CARDINAL LOADING AUGER for grain bin, with motor, like new. 519-674-2724.

GRAIN BIN AERATION FLOORS, various sizes, call for pricing. 519-338-3920.

GRAIN BINS, 19' & 21', new aeration floors, \$2100. 705-799-7262.

GRAIN DRYER 5430

ALLIED 620-B GRAIN DRYER, propane PTO, \$7000. 905-263-2060.

VERTEC 6600 GRAIN DRYER, LP dryer, 20HP, single phase, 7 tiers x 16' updated burner, CSA label. good cond. or email for pics/details, \$12995. 519-851-5007, fords@hay.net

OTHER 5490

NECO INLINE GRAIN CLEANER, 8", very good cond, \$1950, OBO. 519-698-0081.

FETERL INLINE GRAIN CLEANER, 8", hyd driven, \$1200, OBO. 519-698-0081.

HARVESTING

COMBINES

6010



1996 NH TX66 COMBINE pick up head, 6R corn head, 3300hrs, rebuilt straw chopper, 1 season on new rear tires, grain tank cover, stored inside, \$32900. 613-433-6464.



6601 JD COMBINE \$3500. B&M Agri Parts 519-323-4375.



JD 9650 STS 4wd, price \$69,000. B&M Agri Parts 519-323-4375.



JD 6620 very clean. \$19,900. B&M Agri Parts 519-323-4375.

AC ALL CROP HARVESTER, model #66, \$800, OBO. 905-263-2585.

MF 750 COMBINE, low hrs, 4x38 cornhead, 16'-1859 flexhead with U2 reel, all good cond, \$6000, OBO. 519-683-5249.

JD 930 FLEX TABLE, with F&A reel, \$3500. 519-365-5725.

GLENER MODEL E COMBINE, complete unit with a grain head, pickup for whitebeans and hay, spiked tooth cylinder. 519-683-4878.

2 LILLISTON BEAN COMBINES 2 Lockwood windrowers, centre del, stored inside, field ready. 519-275-0004, 519-275-7641.

BEAN FARMERS, Lilliston 6200 high cap bean combine; Lockwood 6R centre del bean wind rower; front mount 6R Speedy bean pullers. 705-435-7598.

NI 708 UNI-SYSTEM, 2 spare 717 bodies, grain heads & corn heads, many parts, mint cond. 519-355-4627.

JD 4400 COMBINE, diesel, AC, heat, good belts, new BKT tires, 915 head, 3359hrs, nice clean; 8/10, \$8500, OBO. 519-463-5861.

JD 4400 COMBINE, 215 grain head, 443 corn head \$19997, DMC 40" diameter Hi-Cap corn cleaner, \$1900. Tilbury. 519-682-1057.

MF 550 COMBINE, 2450 hrs, cab, air, chopper, 15' flex head, no corn, \$10900. 905-986-5068.

JD 6600 COMBINE, diesel, 1976, elec header height control, straw chopper, well maint, JD 215 flex head, new knife, JD 443 cornhead, narrow row, storage wagon/each head, very good cond. 519-347-2745.

410 MF COMBINE, cab, straw chopper, low hours, 13' grain head.

960 CASE COMBINE, 12' grain head, 2R MF 24 cornhead, cab, straw chopper, heater.

660 SPECIAL COMBINE, spiked teeth, pickup header, cab, straw chopper, many extra parts.

519-436-4478.

DEUTZ R5 COMBINE, 4WD, 4721 engine hrs, 3316 separator hrs, totally rebuilt, always shedded. Grain header, series 500, 20', floating cutter bar. Corn header, 6R, 30". \$39500. 519-791-2163 or (519-326-1262 evenings).

JD 216 FLOATING GRAIN HEAD, Best offer. 613-378-2255.

JD 7700 COMBINE, turbo hyd static, 213 foating grain head, BO. 613-378-2255.

AC GLEANER K COMBINE, Soybean special. 613-378-2255.

CASE 5088 COMBINE, 700 Sep hrs, 4WD, Michelin tires, exc cond. 519-536-0352.

JD 9550 COMBINE, level land with duals, exc cond. \$85000. 519-949-1098.

1660 CASE INT COMBINE, 2WD, auto head, rock trap, chopper, 2923hrs, 1020 - 20' grain head, JD 643 - 6R corn head, header wagon, \$34500. West Lorne. 519-768-2821 or 519-768-1736.

1 UNI 708 HARVESTER, with a snowblower. 519-355-4627.

JD 7720 COMBINE TITAN II, new rasp bars, concave, feeder house chain, motor in exc shape, c/w chopper (unattached). 705-772-9810.

GLENER E COMBINE, 10', exc cond. \$1500. 905-396-7533.

JD 9760 SDS COMBINE, including 635F flexhead, 4wd, 20.8x42 duals, contour master, straw spreader, high capacity auger, side hill shoe pkg, GPS, grain loss monitor. \$125000. 519-521-0126.

JD 9570 COMBINE, 930 flex, 606C corn head. 905-870-7936.

JD 9660 STS COMBINE, 1420 separator hrs, 2006 model, mint cond, \$120000. 519-464-2855.

MF 550 COMBINE, w/13' flexhead, good cond, \$7500 OBO; MF 1144 wide corn head, 4R, good cond, \$1200 OBO. 519-347-2457.

2011 JD 9670 STS COMBINE, 4WD, 1650 eng hrs, 1200 sep hrs, long auger, dealer ASI June 2015, field ready, \$219000. 905-687-0365.

M2 GLEANER COMBINE W/ 2 HEADS 1979, 4WD, /Hydrostat, 6r Corn head, 316 flex head w/ auto header height, straw chopper, monitors, & ac, \$15000, OBO. 519-881-0971. albins@explornet.com

MASSEY FERGUSON 550 COMBINE, w/chopper, corn & soy bean special, 4R cornhead, pick up head and 15' straight cut head, \$9000, OBO. 519-348-8331. 519-348-8331.

NH CR6090 355 hp, 4wd, dlx chopper, 2012, 1360 hrs \$215,900. ESM Farm, Wallenstein 519-669-5176.

GRAIN CARTS

6040



KILLBROS GRAIN BUGGY \$7,500. B&M Agri Parts 519-323-4375.

4 TURN PURNCO GRAIN WAGON 2- 250 bushels, 2-300 bushels, good under carriage, \$2000 each. 905-797-2428.

2012 DEMCO 750 GRAIN CART, \$23,000. 905-687-0365.

GRAVITY WAGONS

6050



NEW BACH-RUN 387
box w/12T horst gear,
chain, 305 Tire

\$5,200

Bach Run Farms
519-595-4029



TURNCO BOX AND MARTIN GEAR
150 bushel, 11L-15 Inch tires, good shape. \$1650. Dan Seifried, Harriston. 519-338-2688.



TURNCO GRAVITY WAGON good cond, \$1250, OBO. 905-929-7896.



AGRIMASTER A600 GRAVITY BOX
425 tires, 20 to gear, 600 bu., in stock. \$11,000. Howe's Farm Equipment 613-678-5599.

SM GRAIN WAGON, for sale. 905-230-0838.

RUNNING GEAR, with tires, good shape, \$450. 519-326-1770.

UNVERFERTH GRAVITY WAGON, extensions & ladders, 12 ton running gear, stored inside, like new. 519-443-8732. No Sunday calls.

700 BUSH BELLY DUMP GRAIN WAGON, dual wheels, good condition, new tarp. \$6000.OBO. 519-825-3751.

4 - KILLBRO'S GRAVITY BOX, 400 bushel cap, rolling tarps, good cond. 519-791-2163 or (519-326-1262 evenings).

ALL STEEL WAGON, 20'x8'x32", dual wheeled. \$650. 519-791-2163 or (519-326-1262 evenings).

RUNNING GEAR, 6 ton, for gravity box. \$700. 519-791-2163 or (519-326-1262 evenings).

GRAVITY WAGONS, 200 bushel, JD running gear, loading auger, good cond, \$1500 for both. 519-355-4627.

3 GRAVITY WAGONS, with undercarriage, 2 Turnco, 300 & 200 bushel, 1 Market, 250 bushel, all with safety chains & lights, all in good cond. 519-347-2745.

2 J&M 385 GRAVITY BOXES, w/ Horst 205 truck tire running gears, \$4500 each. 519-669-2309.

2 UNVERFERTH WAGONS, 275 bushels each, \$1200 each. 519-359-5833.

HORST, 12 ton running gear with rocking boosters, \$1800. 519-505-3418.

RUNNING GEAR, 6 ton, \$200. 519-505-3418.

MARKET GRAVITY BOX, 340 bushel, lights, truck tires. 519-820-9666. Leave message.

HEADERS - CORN 6060



JD 645 POLY TINE Very good condition. \$9,500. B&M Agri Parts 519-323-4375.



CRESSONI 8 row chopping corn head. \$25,000. B&M Agri Parts 519-323-4375.



JD 693 6 row corn head. \$12,900. B&M Agri Parts 519-323-4375.



JD606C w/Auto Header Height, 1600 acres, \$39,900. Kearney Planters (519) 678-3206.



CAPELLO QUASAR 8RN Corn Head 540 pto, CIH Flagship, 3 Sensor Head-site Header Height Control, \$54,000. Kearney Planters (519) 678-3206.



CIH 1083 Corn Head. Kearney Planters (519) 678-3206.

MF 44 CORNHEAD, 4 row wide, \$500. 519-289-5648.

NEW IDEA CORN PICKER, 2R wide, \$650. 519-969-1542.

NI CORN PICKER, 2R, \$2000. 905-327-4408.

MF 44 CORNHEAD, 4R, exc cond, little use, no longer needed, \$500, OBO. Chatam. 519-359-5833.

REDUCED JD 608C CORNHEAD, 2009 & 2010 models, knife rolls, hyd stripper plates, ground height sensor, contour master, poly snouts. Serviced by JD, field ready. 519-983-6332.

JD CORN HEAD PARTS, row units & tin, 6R, 30" Gleaner head, \$2000. 519-882-1686.

NH 822 CORNHEAD, 2R, good cond, \$750. Tavistock area. 519-496-2725.

NI CORN PICKER, 2R, great shape, \$2000. 519-683-4878.

JD 444 CORNHEAD, 4R, 36", field ready, good shape. 519-687-2848

#443 JD CORN HEAD, new rollers, used for 100 acres, \$3600. 519-674-2629.

GERINGHOFF CORN HEAD, 6R chopping, header height control, down corn augers, mint cond. 519-536-0352.

NEWER 844 CORN HEAD, good cond. 905-818-9300.

JD 893 CORN HEAD, knife rolls, good cond, \$17500. 519-882-1686.

JD CORN HEAD, great shape. \$6500. 705-772-9810.

2010 JD 608C CORNHEAD, with knife rolls, nice condition, \$37000. 905-392-0934.

2 - IH 844 CORN HEADS, one in good cond, the other in exc cond, BO. 519-770-7551.

JD CORN HEAD, 6R, 30", in great shape! 705-772-6572.

Agco Hugger corn head, 8 row @ 22'. \$5,900. ESM Farm, Wallenstein 519-669-5176.

HEADERS - FLEX 6070



C-IH 1020 FLEX HEAD 15 FT, Agris knife, SS Floor, \$3500. Agri-Mobile 905-768-1493.

FREE FARM CLASSIFIED



JD 918 FLEX HEAD \$7500. B&M Agri Parts 519-323-4375.



JD 920F flex head, full finger, contour shafts, exc. condition. Call for pricing. DM Horst & Son 519-669-2520.

JD 930F FLEXHEAD, poly snouts & skid plates, SS floor, stubble lights, PTO shafts, hyd for/aft, full plastic finger auger, no dents, good straight head, \$12000, Horst header wagon, \$1800. 705-563-2180.

CASE IH 2025 FLEX HEAD, air reels, bean & wheat, mint cond. 519-536-0352.

922 F FLEX HEAD, with aerial, exc cond. \$15000. 519-949-1098.

JD 922 FLEX HEAD, poly snouts & skid plates, PTO shaft, SS floor, hyd for/aft. Niagara Region 905-899-2844.

2010 JD 635 FLEX HEAD, exc cond, \$20000. 519-464-2855.

JD 200 SERIES HEADER, 13' rigid grain header. \$1000. 519-496-2725.

JOHN DEERE HEADERS, 635 Hydro-flex head, \$12,500. 7' hay head, \$1500. 519-595-7180.

9115 MF 15' FLEX HEAD, ate model, tear drop reels, good cond. 519-881-8966.

HEADERS - OTHER 6080



JOHN DEERE COMBINE HEAD 10ft auger, 8ft belt pickup, 26 inch feeder house. \$850. Dan Seifried, Harriston. 519-338-2688.



JOHN DEERE 215 FLEX HEAD w/ header wagon, used last year, hydraulic reel, bolt knife, 15 ft, some new guards. \$2200. Dan 519-338-2688.

JD 635F FLEX HEAD, Contour Master with Horst header wagon. \$25000. 519-768-1657.

MF GRAIN HEAD, 13', straight head. \$400. 519-289-5648.

JD GRAIN HEADER, 15', w/10' Renn pickup, \$2000, OBO. 519-345-2274.

MACDON DRAPER HEADER, 24', with wagon. 705-772-9810.

JD BEAN HEADER, 20", model 218. 705-772-9810.

CASE IH #810 PICK UP HEAD, 12' wide, with Melroe belt #388, good cond. \$150 OBO. 519-934-2722.

JD 643 CORN HEAD, 6R, good shape, \$6500, 2009 Mac Don FD70, 36' draper head, \$57000. 905-687-0365.

JD STRAW CHOPPER, off of a 6620 combine, good cond, \$500. 519-349-2747.

HEADERS - TRAILERS 6090

HORST WAGON, 12 ton, double reach, 22.5 tires on new rims, safety chain, sand blasted & painted, \$2000. 905-382-5995.

PULL-TYPE 6100



CIH 1682 COMBINE \$9900. B&M Agri Parts 519-323-4375.

IH 1482 PULL TYPE COMBINE very good, \$8500. 519-595-7180.

ROTARY 6110

BUSH HOG CORN SHREDDER 15', 3 blade, done only 40 acres. 519-695-6613.

SELF-PROPELLED 6120



NEW HOLLAND FR9040 HARVEST ER 4x4. 6 row Cornhead, Pickup head, Cobmeal head. All 3 heads and processor included. Estate sale. \$285,000 obo 519-531-0169.

AC 100 COMBINE, Self-propelled, good cond. 519-392-6207.

WINDROW 6130

DAHMLAN POTATO WINDROWER, 2 row, hyd tongue, stored inside, field ready, \$4500. 905-531-9819.



FORD 501 SICKLE MOWER 7ft bar, 3ph, new pitman, 540PTO. \$750. Dan Seifried, Harriston. 519-338-2688.



IH 4000 SWATHER \$2,900. B&M Agri Parts 519-323-4375.



MATADOR HAY INVERTER like new, \$5500, OBO. 905-929-7896.

OTHER 6190

JD 4400 FEEDER HOUSE CHAIN, \$500. 519-524-4795.

CHAUFFER FOR JD 9860, fits 70 Series & 9760, \$500. 705-435-2256.

BEAN PULLER, 2R, for Oliver 77. 519-436-4478.

GRIMME POTATO DIGGER, new parts, 4-C2123 belts, 4-467 belt tensioners, \$200 for all. 519-484-2633.

BELTS FOR DION THRESHING MACHINE, including drive belt 50', sudbury area. 705-983-2156.

INT 810 WINDROW PICKUP, 16-18-21-23 series IH combines, good cond, always inside. 416-464-2373.

JD B GRAIN DRILL, for sale. 519-683-4672.

MOTOR FOR NH 1495 SWATHER, for sale. 519-599-7717 or 705-443-0671.

1 SET OF REELS, for a straight hay header for Case 4000 swather, single auger over shot or a complete header, has to have 19 places to bolt on tines. 519-599-7717 or 705-443-0671.

1945 MOUNT FOREST THRESHING MACHINE on steel, 24" cylinder, straw chopper. 519-848-5505.

IHC CORN BINDER PTO, good shape. 519-575-3605.

BELTS FOR A DION THRESHING MACHINE, including drive belt 50', Sudbury area. 705-983-2156.

**BALE WAGONS /
RETRIEVERS****6310**

MARTIN THROWER RACK 6 ton gear, 20ft, heavy built, side doors. \$1350. Dan Seifried, Harriston. 519-338-2688.

HAY WAGON, \$550, OBO. 519-326-1770.

15' WAGON, wood deck, 16" wheels, \$650. 519-365-7500.

STEEL FLAT RACK, 8'x12', twin cyl hoist & pump, \$1500. 519-392-6079.

DION FORAGE WAGON, right hand unload, good cond, \$800. Tavistock area. 519-496-2725.

DION FORAGE WAGON, 15', left hand unload, good cond. 905-563-7389.

WAGON, wooden, 11L15 tires, good shape. 519-374-1048.

2-BALE THOWER WAGONS, 16', wooden, \$750 each. 519-496-2725.

JD 1065 & 953 WAGON RUNNING GEAR, for sale. 519-665-2303 bosomworth@wightman.ca

NH BALE WAGON 1034, 105 bale capacity. \$5500. 519-577-7155.

SCHOOL BUS CONVERTED TO CARRY BALES good cond, stored inside. 519-271-9228.

10 TON HORST WAGON, for sale. 905-870-7936.

DOUBLE BAR FEEDER WAGON, 20', NEW! 519-321-9233.

ALL STEEL FLAT RACK, 25' New! 519-321-9233.

3 DION WAGONS, 1 DION BLOWER, usable cond. 519-227-4882.

MARTIN THROWER WAGON, Martin running gear, good cond, \$650 OBO. 519-347-2451.

GRAIN WAGONS, 150 bu. \$600 each, hay tarps 40x60, \$240 each, 35' Allied auger, no motor, new condition. 519-697-5528.

OAK HAY WAGON, 18', on double reach Horst gear \$1950 or rack only, \$1175. 519-669-1199.

MARTIN THROWER WAGON, & Martin running gear, good cond, \$700, OBO. 519-347-2451.

16 FT THROW WAGON 16 ft Throw wagon \$100 519-934-2511

2 - DION FORAGE WAGONS, for sale. 905-774-4698.

BALERS - ROUND**6315**

CLAAS VARIANT 380RC W/APPLICATOR, 2 AVAIL, \$39,500 **GJ'S - 519 424 9374**



CIH RB454 4'x5' Silage Special w/ Twine & Net Wrap, Magna Wide Pickup, Liquid Inoculator, 540 PTO, Deluxe Monitor \$19,900. (519) 587-2273.



JOHN DEERE 854 SILAGE SPECIAL, KNIVES, NETWRAP \$33,900 **GJ'S - 519 424 9374**



CASE IH ROUND BALER silage special, shedded in off season, exc cond. \$12900. 905-929-7896.



CLAAS 255 ROUND BALER good condition, rotocut with Uniwrap. \$28,500. Howe's Farm Equipment 613-678-5599.

JOHN DEERE 854 BALER, round bales, silage special, 10500 bales, net wrap, 14 knife pre cutter, exc cond, \$29900. 705-563-2180.

AC BALER, small round, 60lb bales. 519-538-4929.

AC BALER, makes small bales. 519-538-4929.

2002 NH 658 BALER, twine tie, approx 3000 bales, exc cond. \$10000. 905-768-5329.

456 ROUND BALER, AVCO New Idea good cond, most belts original. 519-538-4929.

GEHL 1850 ROUND BALER, hardcore, good cond, always inside, \$2500, OBO, at meal time. 519-347-2647.

1996 NH 664 ROUND BALER, Farmer retired. 5x6, Auto Wrap-twine1000RPM, always shedded, \$6000 OBO. 519-529-3698.

**BALERS - SMALL
SQUARE****6320**

NEW HOLLAND 67 BALER 540 PTO, low acres, really good for its age, used this season. \$1250. Dan Seifried, Harriston. 519-338-2688.



CASE IH 8575 SQUARE BALER Large, good condition. \$24,500. Howe's Farm Equipment 613-678-5599.



NEW HOLLAND 311 BALER with thrower. Call for pricing. DM Horst & Son 519-669-2520.

BALE THROWER, off NH 273, new belts, good cond. 705-652-3874.

BALE THROWER, for Massey or Ghel small sq baler, complete, could del, \$300, OBO. 519-969-1542.

MF #22 BALE THROWER, belt driven, fits #12 or #124 baler, \$500. 705-324-0920.

NH 575 BALER, Small square, no thrower, very good cond, always shedded. 519-846-5726.

MF #10 BALER, Small sq. \$800. 519-363-6338.

NH HAYLINER 67 BALER, small sq, A+ cond, stored inside. 519-458-4756.

NH 273 BALER, with thrower, \$1200. 519-496-2725.

GT 520 DEUTZ FAHR BALER, working cond, always shedded. 519-848-6992. Evenings.

JD 336 BALER, electric control thrower, \$3000. 519-374-1048.

INTERNATIONAL 440 Small Square Baler International 440 \$1000 BO 519-934-2511

BALERS – LARGE SQUARE 6325

NH 273 SQ BALER & THROWER super sweep p/u, good cond, low use, \$2000, OBO. 519-347-2451.

NH 570 BALER W/THROWER & HYDRO FORMATIC, clean, field ready and always shedded. 519-392-6734.

CASE IH LB433 BALER, lg sq 3500 bales, 3x4, tandem axle, roto cut, auto lube, Harvest-Tec applicator, like new. 519-301-5001.

DISC MOWERS 6330



JD 630 DISC BINE mint condition. \$17,500. B&M Agri Parts 519-323-4375.



DCX 131 CASE IH DISC BINE low acreage. \$17,500. B&M Agri Parts 519-323-4375.



JD 635 DISC BINE \$16,900. B&M Agri Parts 519-323-4375.



NEW HOLLAND 7230 DISC BINE very nice. \$21,000. B&M Agri Parts 519-323-4375.



NEW HOLLAND H7560 Disc Mower Conditioner. \$13,800. Howe's Farm Equipment 613-678-5599.



PERFECT DR440 3PTH Orchard Mower, Cutting Width 9'7" - 14'5" with 2 Hydraulic Adjustable Outside Wings \$8500. Doughty & Williamson (519) 587-2273.



JD 946 DISCBINE Impeller, exc. condition. Call for pricing. DM Horst & Son 519-669-2520.

1999 HESSTON DISCBINE, in good cond, model#1320, \$7000. 519-847-5715.

2006 NH 1432 DISCBINE, exc cond. \$15000. 905-768-5329.

JD 530 DISC MOWER, roller conditioner, 9'9", \$500. 519-698-2200.

FORAGE HARVESTERS 6335

AVOID THE FALL RUSH ORDER YOUR LEBANON SILAGE PROCESSOR NOW.

SEVERAL JD AND NH HARVESTERS FOR PARTS

NH 790 new knives, serviced, with 790 W P/U. \$7000.

HORNING PROCESSOR for JD 3970, used. Call.

JD 3950 rebuilt, comes with 5' hay pick-up. \$7500.

JD 3RN and 2RN corn heads. Several Available.

JD 7' green PU rebuilt. \$1800.

NH 824 CORN HEAD low acres, very nice. \$4,500

FULL LINE OF JD AND NH AFTER MARKET & USED PARTS.

Lebanon AG Service 519-291-6802

NH TANDEM AXLE KIT, for pull type harvester; 230 or 240. 519-698-2427.

NH 718 FORAGE HARVESTER, 1R Corn head & hay pick up. 905-563-7389.

NH 782 FORAGE HARVESTER, with hay head, god cond. 905-818-9300.

CASE IH FORAGE HARVESTER, 8725 hay pick-up & 2R cornhead, real nice. 905-774-4698.

NH 892 FORAGE HARVESTER, 2R narrow corn head, hay pick up, good cond. 519-227-4882.

JD 3950 FORAGE HARVESTER, with Horning processor, 2 row CH, 5.5' p/u, \$10000 firm. 519-291-5891.

NH 880 HARVESTER, pull-type, 1000 PTO, cut & throw, in working order, \$500. 519-698-1086.

HESSTON 2000-150 FORAGE HARVESTER, Eastern Farm 16' wagon with roof, 8 ton, Dion 16' left hand, 10 ton, NH 25 blower, 2R Corn head narrow, \$3600 for all. 705-932-5387.

2-JD 3800 FORAGE HARVESTERS, one with pickup electric controls and the other 2R narrow corn head with recutter screen, \$1000 each. 519-349-2747.

NH FP240 harvester, tandem, metalret, processor, 2009. \$32,900. ESM Farm, Wallenstein 519-669-5176.

FORAGE HEADERS 6336



MASSEY FERGUSON PICKUP HEAD 6ft grain swath, steel finger tooth, depth wheels. \$675. Dan Seifried, Harriston. 519-338-2688.

FORAGE BLOWERS /BOXES 6340



16' FORAGE KING BOX & HORST 12T WAGON 10.00 20 tires, 3 beater, LH unload, all steel w/ plastic floor, exc cond, \$9800. 905-957-3807, mapfms@aol.com



DION FORAGE WAGON, \$3800. B&M Agri Parts 519-323-4375.



NEW HOLLAND FORAGE WAGON \$2600. B&M Agri Parts 519-323-4375.



GEHL 970 FORAGE WAGON very good cond, stored inside, \$5000, OBO. 905-929-7896.



CIH 600 FORAGE BLOWER Call for pricing. DM Horst & Son 519-669-2520.



Fill Silos Fast!
with Blow Decks

- Dump at the blower and go for more!
- All hydraulic drive
- Easy transport and setup

DumpDek e.Horst
enterprises
dumpdek.com • 613.758.9902

GEHL SILAGE BLOWER, w/ w slash pipes. 905-230-0838.

GEHL FORAGE BLOWER, high throw, \$500. 905-327-4408.

NH 28 FORAGE BLOWER, good cond, \$750. Tavistock area. 519-496-2725.

GEHL 1540 FORAGE BLOWER, good cond. 519-757-5708.

NH #28 SILAGE BLOWER, for sale. 905-563-7389.

NH # 25 FORAGE BLOWER, good working cond, can deliver, \$500. 519-236-4976.

CASE IH 600 FORAGE BLOWER 3300 519-291-7522.

GEHL 1540 FORAGE BLOWER, like new, must see. 519-462-2650.

2014 DION FORAGE BLOWER, exc cond, \$8400. 519-292-1693.

5300 MILLER PRO FORAGE BOX, like new. 905-818-9300.

INTERNATIONAL 56 FORAGE BLOWER, working cond, \$200. 519-881-0509.

Dion 10R forage box, 16', 3 btr, roof, rh unload, wagon. \$3,900 ESM Farm, Wallenstein 519-669-5176.

NH 8 LH unload, 3 btr; Horst wagon \$1,950. ESM Farm, Wallenstein 519-669-5176.

**MOWER
CONDITIONERS
WINDROWERS** 6350



VERSATILE 400 HYDROSTATIC 12ft, finger reel, 6cyl Ford engine. \$2,200. Dan Seifried, Harriston. 519-338-2688.



HESTON PT10 LATE MODEL works good, 9ft, steel rubber rolls, owners manual, one owner. \$2,200. Dan Seifried, Harriston. 519-338-2688.



WIDEMAN HAY CONDITIONER extra wide for 12 windows, exc cond, \$9000 OBO. 905-929-7896.



JOHN DEERE 4990 Disc Mower Conditioner, good condition, self propelled. \$42,500. Howe's Farm Equipment 613-678-5599.



IH 4000 SWATHER 12' dual auger head. Call for pricing. DM Horst & Son 519-669-2520.

MF 1459 SICKLE MOWER, 5 years old, \$8000 firm. 905-327-4408.

NEW HOLLAND 166 INVERTER, good working cond, \$3800, OBO. 519-326-1770.

INT SWATHER, Model 201, 12' auger head, not running, \$750, OBO. 519-347-2451.

2004 NH 1432 DISCBINE FLAIL CONDITIONER, good shape. Brian. 519-796-3369.

NEW IDEA 272 CUT CONDITIONER, field ready, 613-473-4131.

FLAIL MOWER, best offer. 905-537-6977.

LAND PRIDE FINISHING MOWER, 72', 3pth, PTO, \$1600. 519-758-4183.

INT HAY MOWER, 7', trail type, exc cond, \$475, OBO. 905-734-4033.

IH C-28 SICKLE MOWER, 3pth, 7' cut, good shape, \$500. 519-525-0374.

RAKES/TEDDERS 6355



KRONE 46T
DRAWBAR, 4.6M, \$11,900
GJ'S - 519 424 9374



ENROSSI/FAZA WHEEL RAKES
4-\$1160, 5-\$1325, 6-\$1495
GJ'S - 519 424 9374



INTERNATIONAL 30 RAKE adj height, 5 wheel finger tooth, new teeth. \$750. Dan Seifried, Harriston. 519-338-2688.



KUHN GA7302DL RAKE good condition, double spinner. \$13,500. Howe's Farm Equipment 613-678-5599.

KUHN GA300GM ROTARY RAKE, good working cond. \$2800, OBO. 519-807-1644.

NH MODEL 56 SPINRAKE, good cond. \$500 OBO. \$500 705-323-8074.

JF SIDE RAKE, PTO drive, 3pth, paint faded, belt & chain both good, extra teeth incl, good working order tedding. 519-294-6564.

COCKSHUTT 311 HAY RAKE, roll bar, fresh paint, exc cond, \$900, OBO. 519-347-2451.

MF HAY RAKE, #36, roll bar, fresh paint, exc cond, \$1050. 519-347-2451.

NEW IDEA HAY RAKE #402 good cond. \$800. 519-683-4672.

BAUMAN HAY TEDDER, 7', good cond, ready to go, Thamesford area, \$1900. 519-808-9672.

NEW IDEA 402 RAKE, for sale. 519-683-4672.

NH 256 HAY RAKE, good working cond. \$975, OBO. 519-664-1706.

ROTARY MOWERS /SICKLE MOWER 6360



FORD ROTARY BUSHHOG GRASS CUTTER works well, slip clutch, 3ph, 5 1/2 ft. \$850. Dan Seifried, Harriston. 519-338-2688.



CASE 10 SICKLE MOWER hydraulic lift, 7ft bar, pitman type, 540 PTO. \$575. Dan Seifried, Harriston. 519-338-2688.

INT SICKLE MOWER, 7', 3 pth. 705-844-1493.

BUSH HOG ROTARY CUTTER, heavy duty, Model #13414-SS-1000, 13' wide, 85 acres completed. 519-695-6613.

6' BUSH HOG, Rarely used. \$1500. 905-699-8256.

JD MX8 ROTARY MOWER heavy duty, like new. \$4700. 519-669-2309.

BUSH HOG, 6', \$1250. 905-643-1402.

MASSEY FERGUSON MOWER, 7', 3pth. 519-421-4393.

COCKSHUTT 415 MOWER, for sale. 519-683-4672.

5' PITTSBURGH ROTARY MOWER, new knives, \$575. 519-897-5534.

STALK CHOPPERS /FLAIL MOWERS 6370



MASSEY FERGUSON 410 STRAW CHOPPER 48", 21 knives, belt drive. \$375. Dan Seifried, Harriston. 519-338-2688.



NH 38 CROP CHOPPER Call for pricing. DM Horst & Son 519-669-2520.

GEHL FLAIL STALK SHREDDER, 6', PTO, hyd lift, pull type, \$425. 519-354-9584. After 6pm.

BRADY STALK CHOPPER, 12', good cond, \$2000 OBO. 519-347-2451.

MOTT 90" FLAIL MOWER, 3pth, \$950. 905-396-7533.

GEHL F072A CHOPPER, blower hood to load wagon, almost new drive belts. \$1000. 519-683-4672.

6' FLAIL MOWER, comes with identical one for parts. \$700. 905-699-8256.

TUB GRINDERS /BALE PROCESSORS 6380

INT BELT DRIVEN GRINDER. For Sale. 519-436-4478.

WIC SMALL BALE CHOPPER, 8HP Honda, good condition. \$1300. 519-484-2633.

OTHER 6390



CASE 18FT SKELETON TUBE type hay elevator, 110 motor, working order. \$575 Dan Seifried, Harriston. 519-338-2688.

PRONOVOST SILAGE MACHINE, 6200 bale tuber, all new hoses, new larger electric start motor, repainted, \$7500. 905-957-7337.

BACK BALE SPEAR, 3pth, \$350. 905-648-3793.

BALE SPEAR, 3pth, heavy built, \$350. 905-382-5995.

JD BALE SPEAR, quick catch, \$250. 905-382-5995.

HAYBINE CUTTERS, rivot holes 1/4" on 2" centers, genuine cockshutt part number 2564X, brand new, 75 cutter, \$100. 519-484-2633.

NEW IDEA 701 UNI SYSTEM, power unit, chev gas, 11' grain head, finger pick-up, \$1500. 613-489-3817.

CUSTOM BALE UNROLLER, for sale. 519-529-7715.

NH 489 HAYBINE, working cond, always shedded. 519-848-6992. Evenings.

32' EBERSOL BALE ELEVATOR for sale. \$750. 519-496-2725.

479 NH HAYBINE, new rolls, new knife & guards, new belt, fresh paint, \$2500. 519-347-2451.

OLIVER/ COCKSHUTT 415 HAY MOWER, hyd lift installed. \$750. 519-683-4672.

18' HAY WAGON with 810 undercarriage. \$1000. 905-648-3793.

SUPERIOR GEAR BOX, for JD 430 round baler, aluminum case, part #B01PC-1915, will fit 430's or 530's. 519-599-7717 or 705-443-0671.

STOOKER, a bit rusty, works well, good cond, \$100. 519-765-1691.

NH ROW INVERTER, for parts. 519-482-9902.

THROWER BELT, at flywheel, for 273 NH baler, paid \$130, sell for \$100. 519-347-2451.

LAWN & GARDEN

OUTDOOR POWER EQUIPMENT 6400

TROY-BILT ROTOTILLER, Super Bronco, rear-tine, 6.5hp, \$599. 519-758-4183.

RIDING LAWN MOWERS 6420



JOHN DEERE F935 60" front mount mower, Deisel, \$3495. Profota's Farm Equipment 519-354-5100.

KUBOTA T1700 RIDING MOWER, 18hp, 48" cut, like new. 905-230-0838.

REEL MOWER, Jacobsen Greens King 62 triplex, hydro static, 5'cut c/w K301 Kohler 12 hp electric start, \$500. 519-484-2633.

KUBOTA B6200 HST, diesel, 2WD, hydro-stat, 3pth, rear pto, and 48" mid mounted mower, \$4900. 519-484-2633.

JD 710 LAWN MOWER, excellent condition. 519-524-4795.

1965 INT CUB CADET LAWN TRACTOR, restored, many options; creeper gear, rear PTO and more.\$1500. 519-345-2255.

Kubota G1800 hrs, 54" deck, 3cly diesel. \$3500. Callaghan Farm Supply, Lindsay 705-324-8686.

Kubota BX1830 18hp, 4wd, 54" mower, 2005, 330 hrs, \$8500.00 Callaghan Farm Supply Lindsay 705-324-8686

SNOW REMOVAL 6440

2-6' TAGALONG SNOWBLOWERS \$200 each. 705-384-5505.

LEON BLADES, 14'-6 way for 4WD, \$8000. 12' hyd angle for FWD tractor. \$5500. Both like new. 519-354-3636, 519-401-4304.

SNOWBLOWER, 7', 22" auger, good working cond, \$600. 519-317-8508.

OTHER 6490

Brubacher Drums



PLASTIC PRODUCE TOTES

- foldable for easy storage
 - various sizes available
 - volume order discount
- Call for pricing.

855 Arthur St. S., Elmira
519-664-2958

5 HP GARDEN TILLER, rotary, new motor. 519-699-5399.

36" LAWN ROLLER, used only once, \$200. 519-839-4244.

3 WHEELED CUSHMAN TRUCKSTERS, 6spd trans, hyd dump box, PTO, gas powered. 519-758-4183.

SAND TRAP TRACTORS, gas, hyd drive, 12hp, like a mini dozer, \$399 and up. 519-758-4183.

60" WOOD BELLY MOWER, excellent shape. \$750. 905-797-2428.

GARDEN WAY CART, good cond. 519-799-5701.

LIVESTOCK & MANURE HANDLING

CHUTES/FENCING /HANDLING 6520

WANTED: PINTLE STABLE CLEANER CHAIN, good cond, clock wise. 519-525-0681.

FEED GRINDERS /MIXERS 6540



SEQUE MIXER 2310 like brand new. \$27,500. B&M Agri Parts 519-323-4375.



JAYLOR 610 MIXER \$12,500. B&M Agri Parts 519-323-4375.



IH 1250 MIXMILL excellent condition. Call for pricing. DM Horst & Son 519-669-2520.



ARTS-WAY 425 MIXMILL very clean. Call for pricing. DM Horst & Son 519-669-2520.



NH 355 MIXMILL, gear, excellent condition. Call for pricing. DM Horst & Son 519-669-2520.



GEHL 95 MIXMILL gear, load & unload. Call for pricing. DM Horst & Son 519-669-2520.



FARMHAND 875 hyd mixmill scale. Call for pricing. DM Horst & Son 519-669-2520.



NH 352 MIXMILL good condition. Call for pricing. DM Horst & Son 519-669-2520.

FARMATIC HAMMERMILL, 5hp, 2-feed carts, 3-limit hoppers,\$2000. 905-263-2060.

NH 357 MIX MILL, parts machine, various screens. BO. 519-363-6016.

HAMMERMILL, belt driven; 50' belt. 519-683-4878.

VALMETAL TMR MIXER, good cond. 519-757-5708.

INT 1050 MIX MILL, for sale. 519-485-0330.

WIC 52 FEED CART, 5hp Honda, electric start, hydrostatic. 519-674-2724.

LUCKNOW TMR MIXER, 50-60 cows, stairs are incl. 519-348-9620.

VALMETAL BELT FEEDER, 60'. 519-348-9620.

NH 352 GRINDER MIXER, PTO, exc cond. 519-532-5281.

PATZ TUMBLER MIXER, with scale. 519-374-1048.

760 ROTOGRINDER, good working order, \$7500, OBO. 705-340-3193.

GEHL 95 MIXER, 21" mill, exc shape. 519-485-0330.

FREE FARMER CLASSIFIED
www.Farms.com/Classifieds/

**FEEDERS/
WATERERS/BARN
EQUIPMENT** 6560

5-PLASTIC WATER BOWLS, with floats, \$75 for all. 519-458-8850.

USED WET & DRY SINGLE HOG FEEDERS, good cond, \$95. 519-501-7191.

BARN & DAIRY EQUIPMENT, drive & 24' ramp. 905-818-9300.

EXTRA HEAVY CONE ROUND BALE FEEDER, holds two round bales, \$1100, OBO. 519-529-7765.

ROUND BALE FEEDER, 8' diameter, good cond, \$300. 905-336-1146.

20' TOMBSTONE FEEDER WAGON, NEW 5' bunk feeder with galvanized hay rack. 613-929-4964.

100' TAPER BOARD FEEDER, new 19" chain. 519-799-5701.

**MANURE
HANDLING/
SPREADERS** 6580

SALES



GREAT PRICES

**REPLACEMENT
PADDLES FOR
NEW HOLLAND &
JOHN DEERE
BEATERS**

**In Stock:
Manure Spreader Beaters**

**Call Marvin
519-338-3505**
Harriston



RECON. 5000 US GAL with new 850 30.5 tires, like new. \$36,500.

**COMING
RECON. 4000 US GAL**
Call for Details

USED TIRES IN STOCK

- WANTED -
5000 & 6000 gallon
old tankers

**MORE SIZES AVAILABLE
519-669-5772**
WEST MONTROSE

AEYWAY 10ft, Trailer mounted 9.5 x 15.9, \$7,000.

HUSKY 4" 8ft Hytec, \$1,800.

HUSKY Rim For 32" Wheel, \$500.

HUSKY 15-25' Adjustable Drag Hose boom, \$12,000.

HUSKY Used Hubs and Parts For Axles Available, Call.

HUSKY 20FT, 10" Load Pipe with Legs, \$500.



800-349-1122



NH 195 SPREADER top beater, endgate, hyd apron, good condition. Call for pricing. DM Horst & Son 519-669-2520.



H&S 2602 V-BOX SPREADER exc condition. Call for pricing. DM Horst & Son 519-669-2520.



HAGEDORN 5290 VB SPREADER good condition. Call for pricing. DM Horst & Son 519-669-2520.



JD 785 HYDRA-PUSH TB end gate, 540 PTO. Call for pricing. DM Horst & Son 519-669-2520.

NH 185 MANURE SPREADER, tandem axle, double beaters, endgate, new apron charin, good shape, Ailsa Craig. 519-293-3059.

NH 518 MANURE SPREADER, good shape, \$2200. 905-648-3793.

INT 550 MANURE SPREADER, double upper beaters, new floor, good working cond. \$2600, OBO. 519-326-1770.

8024 KNIGHT MANURE SPREADER, side delivery, very good shape. 519-374-1048.

TSF MANURE INJECTORS, 16', for drag line, swivel coulters, hyd distribution, double swivel hookup, flow meter, guage wheels, less than 100 acres, mint cond. \$26500, OBO. 519-808-3725.

NEW IDEA MANURE SPREADER, 1500 gallon, liquid vacuum spreader. 519-527-1482.

HUSKY MANURE SPREADER, 2400 US gallons, 21.5x16.1 tires, always washed & stored inside, exc cond. 519-291-6479.

COCKSHUTT #11, ground drive manure spreader. 519-485-0330.

WEBER 1600G TANDEM VACUUM SPREADER, good cond, \$3000. 519-348-9781.

JD MODEL R SPREADER, good cond. 613-360-3710.

OTHER 6590



HOULE PUMP for water or manure, 6 inch, hoses included, 3PH, 540 PTO. \$1650. Dan Seifried, Harriston. 519-338-2688.

LIVESTOCK V-BAR, brand new, 6'x2', metal galvanized slats, never been used! 519-848-3934 or janwilive@hotmail.ca.

OTHER EQUIPMENT

**BLADES/BOX
SCRAPERS** 6620

KUBOTA RTV1140 2014, 4 seater, with tracks, 82HRS \$19900. Callaghan Farm Supply. Lindsay 705-324-8686

EVERSMAN LAND PLANE, approx 12' wide, ready to go, del arranged, BO. 905-382-5995.

5' PUSH BLADE W/ FRAME, could be made into 3pth, \$200. 519-392-6079.

4' STEEL BLADE, front mount, \$50. 519-392-6079.

HYDRAULIC ANGLING BLADE, 8', 3pth, heavy duty. \$750. 519-791-2163 or (519-326-1262 evenings).

SCRAPER BLADE, 3PTH, 6', call after 6pm. \$250. 905-939-9076.

BOX SCRAPER, 3pth, 6' wide, 18" high, like new, can del, \$525. 519-236-4976.

IRRIGATION EQUIPMENT

6630



BAUER RAIN STAR IRRIGATION REEL model# 110-3300, hose is 4" in diam x 800' long. 519-669-9000 or evenings 519-669-5022.



ROVATTI T3-80AE Up to 470 GPM, PTO Centrifugal Pump on 2 Wheel Cart \$3400. Doughty & Williamson (519) 587-2273.

5" FOOT VALVE, \$200

TIGER FLEX HOSE, 5"x 8', new but weathered, \$75.

BAUER RAINSTAR, T31-75-300, 2.5"x 980' hose, \$2250.

SUCTION PIPE, 6" x 41', with 6' Tiger Flex hose, \$200.

BERKELEY B2TPMS IRRIGATION PUMP, 2.5" NPT in and 4" out c/w 10hp 230V single phase motor, \$1200 firm.

519-484-2633.

HONDA VOLUME PUMP, 5.5HP 3" inlet, 3" output, with both above hoses, \$125. Peterborough Area. 705-750-8493.

PROMINENT FLUID INJECTION PUMP, model # comb1201. \$350. 519-484-2633.

POST HOLE DIGGERS

6640

HYD POST PUSHER, \$500. 905-643-1402.

3PTH POST HOLE AUGER, good cond. 705-844-1493.

POWER UNITS

6650

AIR COMPRESSOR, small. 519-699-9409.

MIG WELDER, 250amp, industrial, made in Canada, 3 phase input, 230/460/575V, 100% duty cycle, \$750 OBO. 519-586-9884.

CAMPAGNOLA PORTABLE AIR COMPRESSOR, c/w hose wheel, pneumatic pruners with 60" aluminum extension, \$1500. 519-484-2633.



DEMO UNIT - KARCHER HDS 3.5/3.0 LIBERTY 220V, Diesel Fired, Hot Water, 3000 PSI @ 3.5 GPM, List Price \$7000, Reduced to \$5500



USED HOT WATER HDS3.5/35 3.5 gpm @ 3500 psi 13 hp Honda / Diesel Fired \$3800



USED KARCHER HDS 3.5/30 3.5 GPM, 3000 PSI, Diesel Fired Electric, Hot Water, Models range from \$2800-\$3200



USED KARCHER HOT WATER WASHER 3000 PSI @ 2.8 GPM, 5.5HP, Honda GX Engine, \$1999

Karcher Professional Wash Systems
1-866-470-WASH

2 PRESSURE WASHERS, 4gal/min & 6gal/min. 519-529-7715.

DYNABLAST HOT WATER PRESSURE WASHER, propane, 3500lb PSI, hose&reel, OBO. \$2100. 519-538-2268.

LKS POWER HACKSAW, auto shut off, like new. 519-799-5701.

PRECISION AG EQUIPMENT/ SOFTWARE

6660

AUTOFARM GUIDANCE SYSTEM, serial #B8010172525, like new. 519-799-5701.

MISCELLANEOUS 6690

SALES, SERVICE & PARTS FOR ALL MAKES AND SIZE OF AIR COMPRESSORS... NEW OR OLD

FRANK AIR COMPRESSORS

Dennis Frank

2315 Floradale Rd., Unit B Floradale, ON NOB 1V0

Cell: 519.577.4914

Tel: 519.669.8949

Fax: 519.669.9406

A FAMILY BUSINESS FOR OVER 35 YEARS

e-mail: fcompressors@rogers.com

DOUBLE LANDROLLER, for sale. 905-230-0838.

VACUMAX U JET, add to your business, start your own business, riding exterior vacuum cleaner, perfect for cleaning parking lots, malls, plazas, properties ect, REDUCED TO SELL, \$1500. 519-894-8645.

DOMINION GRIMM EVAPORATOR 4 x 10 stainless steel pan w/floats, set 4ft grates & doors, 26ft stainless steel chimney, all good cond. 705-652-3874.

4-CAST IRON SWIVEL CASTERS, 8" diam x 2" wide, plate is 4x5", mounting holes are 2 3/4" x 3 3/4", \$200.

4-NORTH BRAND HARD HATS, new! \$100.

GOULDS PUMP, s ubmersible, Model #25G10, 2 wire 230V, single phase, \$400.

PEDISTAL BURKE GEAR PUMP, new! cast bronze, SS shaft, up to 100PSI, choice of 1/2", 3/4" or 1" in & out, \$400 each.

519-484-2633

LANDROLLER, 9' wide. 519-683-4878.

HYDRAULIC CYLINDERS, 4' long, would make great wood splitter cylinder. 519-338-3268.

DANKART LUMBER PLANER, sitting on a float, \$6000. 613-735-6602.

TURKEY EQUIPMENT, sparkup water lines, feeder line, water meter medicator, 2 tube feed hubbers. 519-699-9409.

SEARS CRAFTSMAN RADIAL ALARM SAW, 12", M#2747, Class BE 37845. 519-799-5701.

LITTLE GIANT WASHER PUMP, new! submersible series, 1-Y5 parts, 6' power cord, 110V, 205 gal/hr, \$200. 519-484-2633.

LITTLE GIANT PUMP, new! submersible or inline, model #2E-38NT, 115V, 10' cord, 1/4" MNPT discharge, \$200. 519-484-2633.

STICK WELDER, good cond, \$250. 905-699-8256.

DYNAVENT FAN, needs 5 hp motor, belt driven, \$500. 519-338-3920.

BEAM SCALE, Gold Grand model 903, 1200lbs capacity, 24" sq platform, steel castors, \$350. 519-357-7410.

DIESEL FUEL TANK, 38" diam, 61" long, includes hand pump, \$75. 905-336-1146.

PIPE BENDER, brand new, dyes up to 3 inch, \$200. 519-524-1139.

FORD FRONT WEIGHTS, 3 50lbs, \$20 each, call after 6 pm. 905-939-9076.

1200L WATER TANK in cage, like new, call after 6pm. \$150. 905-939-9076.

40' FREE STANDING T.V TOWER, in 10' sections. 519-338-3268.

STEEL RAIL ROAD TRACKS, for sale. 519-799-5701.

2 FAIRBANKS PLATFORM SCALES, that sit on the floor, 1 on steel wheels. 519-799-5701.

DOVERPAD LIMITED SCALE, steel wheels, weight in KG. 519-799-5701.

NATIONAL MANUFACTURING SCALE, Toronto Canada, lg steel wheels, and swivel tongue. 519-799-5701.

INDUSTRIAL DRILL PRESS, made by A R Willaimson machine company. 519-369-2098.

BUTCHER KETTLE STOVE, Farmers ACME sausage stuffer, 2 gallon, meat grinder #22, good cond. 519-799-5701.

OXY- ACETYLENE TORCHES, personal tanks with complete set, hoses, cutting torches, gauges. \$450. 905-699-8256.

PUREX ACETYLENE CUTTING TORCHES, c/w gauges, regulators and 20' of hose. \$200. 519-484-2633.

RJ 3040 40' DRUM ROLLER, \$18,000 519-436-9127.

CRAFTSMAN STAND UP DRILL PRESS, exc cond, \$150. 905-537-6977.

3 BUZZ SAW BLADES, 29" diameter, \$35 each or \$100 for all. 519-335-6236.

HARDY PRO-6 POWER RAKE 3PH HYD ANGLE, \$4900. Callaghan Farm Supply Lindsay 705-324-8686.

ACTIVE USED 11 X 80 STEEL DECK, call for price. Active Scale, Brantford 519-752-3701.

ACTIVE NEW OLD STOCK 11 X 90 STEEL DECK, call for price. Active Scale, Brantford 519-752-3701.

TOLEDO USED 12X60 STEEL DECK, call for price. Active Scale, Brantford 519-752-3701.

PARTS & SALVAGE

AG PARTS

6710



CANADIAN TRACTOR PARTS DIRECT

Shop online at www.canadiantractorpartsdirect.ca or give us a call **877-319-0059**

TRACTOR PTO SHAFT, 540RPM, 2 U joints on one side, slip clutch, \$200. 519-484-2633.

PARTING OUT, IH drill, NH harvester, JD swather, NH manure spreader, NI picker and sheller. 519-338-2691.

BELT PULLEY, for David Brown 990, 519-227-4882.

NEW SINGLE SEAT, tall back, lots of adjustments, black, for farm tractor or truck. \$125. 519-236-4976.

2 - REAR WHEEL WEIGHTS, off of a Farmall 130, \$150. 519-484-2807.

FIAT F100DT Fiat tractor engine is seized, sold for parts. 7725HRS \$7500 613-979-2556. willtubman@live.ca

ROTARY INJECTION PUMP Rebuilt rotary injection pump. Fits 466 IH \$700. 519-410-1112. normanfarms@optionsdsl.ca

MISC JD 7721 combine parts. 519-846-2312.

DISMANTLED

6720



JD 1850 NO TILL SEEDER, PARTING OUT. B&M Agri Parts 519-323-4375.

MOTORS

6730

ELECTRIC MOTOR, 3HP, 220V \$175. 519-392-6079.

NEW PARALLEL SHAFT GEAR MOTOR, new 1hp, 1700rpm, AC parallel shaft gear motor, 330/575 V. 3 phase gear reduction. 42.8 to 1, output shaft is 1 1/4" diameter, \$500. 519-484-2633.

414 INT BLOCK & HEAD, 200 519-506-3358.

DODGE CHRYSLER 360 ENGINE ran last summer. 519-577-1243.

INT DIESEL BLOCK, 434, 444, 1 crankshaft, \$150 flywheel. 519-506-3358.

TIRES, DUALS, RIMS & CHAINS

6740



Maple Valley Sales & Service
www.maplevalleysales.com
sales@maplevalleysales.com

NOW AVAILABLE A FULL LINE OF TUFFBILT TRACKS AND WHEELS FOR ALL TYPES OF SKIDSTEERS AND MINI-EXCAVATORS!

NEW! SOLID TIRES

CALL US TODAY FOR VERY COMPETITIVE PRICING!
TUFF BILT 705-466-3138

T RAIL DUALS, 20.8x38, \$1500. 519-354-3636, 519-401-4304.

4 28.8X42 TIRES, \$300 each. 519-354-3636, 519-401-4304.

PAIR TRUCK TIRES, 10.00x20 on Dayton rims, good tread, \$125. 519-392-6079.

2-JD RIMS, duals, fit any tractor, snap ons, 519-683-4878.

TIRE CHAINS, 2 sets both 3/8" side link, 1/2" cross link to fit 14.9/28 tires. 519-799-5701.

TRACTOR CHAINS, will fit small tractor like Ford 9N or MH 35, \$250. 705-458-9780.

NEW RIB TRACTOR TIRES, 750/15. 519-524-1139.

SNAP ON DUALS, 13.6x38, with hardware, \$225. 519-354-9584. After 6pm.

VARIOUS TIRES, 245/75/16 Wrangler on an 8 bolt Chevy rim, 235/70/16 Firestone on Chevy rim, \$150 each, OBO. 905-537-6977.

COMBINE DRIVE TIRES, 23.1x26, on 8 bolt rims. 519-436-4478.

SET-T-RAIL DUAL RIMS, 14x30, \$400, OBO, tires also avail. 519-482-9902.

FARM LIGHT TRUCK TIRES, 3-LT225/75R16, 2-ribbed, 1-snow, as new, 8ply, \$200 for all. 519-484-2633.

TRUCK TIRES, 4-10.00/20, on rims, ribbed tread pattern, 12 ply, \$400 for all. 519-484-2633.

FIRESTONE DUALS, 650/65R38, snap-on, \$2800. 519-338-5228.

NEW FIRESTONE TRACTOR TIRE, 13.6x26, \$400 OBO. 519-504-1086.

1 NEW TRACTOR TIRE, 12.4x28, \$350 OBO. 519-504-1086.

2- 16.9 X38 TIRES, bias, good cond. 519-698-0599.

18.4 X 34 TIRE, mounted on an IH rim, suitable for dual or farm use, \$200. 519-484-2807.

2-12.4 X 24 TIRES, mounted on IH rims, good cond, \$400. 519-484-2807.

AC "B" PARTS, front rims, tires & hubs, \$100. for all. 519-484-2807.

TIRES & RIMS, 8 bolt rims, 10.00/20 tires, \$50 each, OBO. 519-770-7551.

TIRES, pair 16.9 x 30, 35% tread. 705-932-5387.

SET OF 13.6X28 REAR TRACTOR TIRES, \$525, OBO. for the pair. 519-520-1779.

1 SET OF RIMS off New Holland Tractor 34" rear & 24" front. 519-846-2312.

1 SET TIRES & WHEELS OFF JD 6000 SERIES, 10.5/80X18 Firestone 70%. 519-846-2312.

TRUCK PARTS 6750

HD ALUMINUM TRUCK BOX, with frame bracket, 24"x24"x32", \$350. 519-392-6079.

HEAVY TRUCK TRANSMISSION PTO, from \$50-\$150. 519-392-6079.

16' ALUMINUM DUMP BOX, with roll tarp. 519-925-8502, 519-939-8598.

TRUCK BOX, 8' wide x 18' long x 9' high, with 2 openings, good cond, OBO, \$900. 905-797-2428.

OTHER 6790

SCRAP METAL, for sale. Come have a look. 519-799-5701.

PTO DRIVES & PUMPS, for highway tractors, manual, shift, or air. 519-524-1139.

PTO CHAR-LYNN HYD PUMP, For sale. 519-526-7581.

WIDE FRONT AXEL, fits IH models A-140, BO. 519-484-2807.

PLANTING & SEEDING

AIR SEEDERS/ AIR CARTS

6810



**APV
COVER CROP, VARIABLE SPEED
GJ'S - 519 424 9374**

DRILLS & CADDIES

6820

IH 510 RAIN DRILL, w/ grass box, 16 run. 905-230-0838.

SUNFLOWER 9412 NO-TILL DRILL, 15', liq fert, cross auger, end swing auger fill, low acres, VG. 519-878-9755.

CASE IH 5500 DRILL, no till, 30', grass seed, liq fert, cross auger for seed filling, markers. 519-363-9451.

JD 750 15' NO-TILL DRILL, complete with scales, in exc working cond, very well maintained. 519-526-7581, 519-524-3863.

INT 510 GRAIN DRILL, 16R Single Disc, clean. \$499. 519-758-4183.

CASE IH 5100 SOYBEAN SPECIAL, 21R, double disc, press wheels, cyl, grass box. 519-674-2724.

CASE IH 5300, 21R, grass seed, bress wheels, cult planter on front, exc cond. 705-772-6572.

JD 750 DRILL, 15', rear hitch, fill auger, scales, bin extension, markers, wide tires, front rank walk-up. 905-382-5995.

IH #10 DRILL, 16R, double disc, grass seed, hyd lift, \$900. 519-897-5534.

2 HIGH FLOW SEED METERS, for JD or 1590 seed drills, \$75 for both, OBO. 519-504-1086.

510 INT SEED DRILL, good cond. 519-882-1128.

MASSEY 33 SEED DRILL, 17R, with grass seeder. 519-524-4795.

JD 1590 NO TILL DRILL, for sale. 905-870-7936.

PLANTERS

6830



KINZE 3500 8/15 #10104. \$53450.
Kearney Planters (519) 678-3206.



KINZE 2500 8/15 #10158. \$41750.
Kearney Planters (519) 678-3206.



JD 450 21x7, GS, PW, Exc. Call for pricing. DM Horst & Son 519-669-2520.



CIH 5300 21x7, DD, PW, good condition. Call for pricing. DM Horst & Son 519-669-2520.



JD 1590 15', markers, scale, monitor, new pins, bushings, boots. Call for pricing. DM Horst & Son 519-669-2520.

WHITE 6100 PLANTER, 6R, low acres, \$20000. 519-354-3636, 519-401-4304.

7000-7200 JD & KINZE, planters, parts, frames, units, no tills, fert, monitors etc. 519-882-1686.

12R KINZE PLANTER, manual fold, liq fert, Keeton seed firmers, finger meters tested, VG. 519-878-9755.

11R KINZE PLANTER, 6R corn, 11R bean @ 15", liq. fert, totally rebuilt, ready to go. 519-878-9755.

449 INT PLANTER, 8R, MH high section spring tooth. 519-436-4478.

JD 7200 PLANTER, front fold, 8RW, exc cond, \$10000.

JD 7000 PLANTER, 4RW, with inter plants, \$2900.

JD 7000 PLANTER, 6R narrow, liq fert, pop up & 28%, Rosen coulters, \$7000.

JD 7000 PLANTER, 8R narrow, dry fertilizer, nice planter, \$8500.

519-882-1686.

FORD CORN PLANTER, 4R, 8 sets of plastic plates, \$650, OBO. 519-969-1542.

CUSTOM BUILT PLANTER, 6x30', twin row on blue jet land tracker cart, dual IHC 500; air units, dual liq fert sys, no-till coulters, as is, \$18000. 905-373-6895.

INT 400 CORN PLANTER, 4R plate, maxi merge units. \$399. 519-758-4183.

INT 400 CYCLO PLANTER, Dry fertilizer. \$299. 519-758-4183.

JD 7200 CORN PLANTER, 12R, narrow, no till, dry fert, vacuum, 200 series monitor, \$19000. 519-765-2064.

IH #56 CORN PLANTER, for sale. 519-683-4878.

JD 7000 CORN PLANTER, 4R, with monitor. 519-524-4795.

IH 56 PLANTER, 7Rx24", Acra plant shoes, cylinder. 519-674-2724.

WHITE 5100 CORN PLANTER, dry fert monitor, 4x30, \$4,500. 519-357-1660.

JD CORN PLANTER, 6R, in good shape, \$6500, OBO. 519-345-2274.

4 ROW TOBACCO PLANTER, with mechanical plug units. 519-358-6405.

JD 1240 CORN PLANTER, 4R, good cond. 519-882-1128.

JD 6R NARROW CORN PLANTER w/ liquid fert, good cond. OBO. 519-595-7180.

2R PLANTER, for parts. 519-369-6082.

JD 2R CORN PLANTER, good cond. 613-360-3710.

OTHER 6890



HERD SPREADER
ATV UNIVERSAL MOUNT \$635
GJS - 519 424 9374

EASY GLIDE MARKET AUGER, 14', with electric shutoff, 1 yr old, \$1800. 519-291-7848.

YETTER CORN TRASH SWEEPS, for 8R, \$150/Row. (Negotiable). 519-983-6848 or 519-983-6400.

2008 JD 1990 QH CCS AIR DRILL, 40', liq fert installed July 2015, new blades & boots 2015, 8800 acres, \$102000, Kinze 3600 planter, 12/23 w/no-till coulters, KTM2 monitor, inner row, \$57000. 905-687-0365.

JD SINGLE DISC FERTILIZER OPENERS, off 16R 7200 planter, liquid boots. 519-807-7903.

SKID STEER LOADERS

SKID STEER ATTACHMENTS 6910



RUBBER TRACKS Off Case 75XT Skid Steer, Like New, \$1995. Doughty & Williamson (519) 587-2273.

BALE SPEARS, skid steer mount & 3pth mount, call for needs and price. 519-758-4183.

SKID STEERS 6920

NEW HOLLAND L125 diesel skid steer excellent condition 12500 \$12500 marinus.2159@gmail.com

KUBOTA 2010 SVL75, TRACK LOADER, 1900hrs, cab, heater, \$47500. Callaghan Farm Supply, Lindsay 705-324-8686

NH L218 60 hp; 2-spd; mech. controls, 72" bkt; 2012, 1150 hrs, \$24,900.

BOBCAT S650 74 hp, 2-spd mechanical, cab & heat, 2012, 725 hrs, \$40,900.

NH LS170 52 hp; new tires, 72" bkt; 2001, 5650 hrs. \$13,900.

NH BB940 3'x3' baler, single axle, manual applicator, 2002, 34840 bales \$32,900.

ESM Farm, Wallenstein
519-669-5176.

TILLAGE

DISCS 7010



KEWANEE 1020 20' disc, 21.5" blades, 8.5" spacing \$6800. Profota's Farm Equipment 519-354-5100.



BRENT CPC 2007 disc ripper 7 shank, 30" spacing \$11,995. Profota's Farm Equipment 519-354-5100.



SUNFLOWER 4010 DISC CHISEL good condition. \$14,000. Howe's Farm Equipment 613-678-5599.



INTERNATIONAL 496 Plain Blades 18.5, 7.5" Spacing, Single Finger Harrow, Dual Wheels on Main & Wings, Scrapers Front & Rear, \$8900. (519) 587-2273.

COCKSHUTT TANDEM DISC, 12' wide. 905-230-0838.

MF DOUBLE DISC, re-built front gangs, 6.6', 3pth, straight unit, \$950, OBO. 905-797-2428.

12' COCKSHUTT DISC, mint cond. 519-348-8170.

1955 CASE DISC, 10' wide, 32 plates with cleaners, manual lift, 2 axels, no damage, \$700. 519-872-2188.

SUNFLOWER, 22', G3-22, hyd fold disc, new blades, \$9500. Aylmer. 519-765-2064.

ATHENS DISC, 15', heavy duty, 18' blades, \$2000. 519-440-8596.

INT 470 WHEEL DISC, 20', 60 gang, manual fold. \$3000. 519-791-2163 or (519)-326-1262 evenings).

FORD(LANDOLL) CHISEL DISC PLOW, 7 shank, good cond, \$2500. 519-320-8768.

10' DISC, wheel disc. 519-443-0063.

GLENCOE SOIL SAVER, 7 shank, spring cushion shanks, \$5500. 519-323-1521.

JD DISC 12' PULL TYPE, with cylinder, with wheels. 905-643-2423.

FIELD CULTIVATORS 7020



3500 KONGSKILDE 23', 5 bar, w/ spool bar rolling harrows \$10,900. Profota's Farm Equip. 519-354-5100.

2 USED DELAVAL VACUUM PUMPS, VMS, VSD, OCC, milk sampler, auto foot bath, selection gates, air compressor. Hunt River, PEI. 902-964-2001.



SALFORD 450 27ft. \$12,500. B&M Agri Parts 519-323-4375.

BERVAC S-TINE CULTIVATOR, 18', double rolling harrows. 519-698-2703.

23-T 3PTH CULTIVATOR, new paint, new tires. 705-323-8074.

GLENCOE CULTIVATOR, 12' wide. 905-230-0838.

16' INT CULTIVATOR, manual wings, levelers on back, c/w cylinder, exc shape. 519-369-2262.

2 TRIPLE K 21' CULTIVATORS, pull type, rolling harrows, S.B.A model, good cond. \$2500 each, OBO. 519-825-3751.

SANDRUM CULTIVATOR, 12', 3pth, leveling plank & rolling harrows, \$475. 519-354-9584. After 6pm.

VEGETABLE CULTIVATOR, S-Tine, 3R, fertilizer attachment. \$2000. 519-791-2163 or (519-326-1262 evenings).

14' CULTIVATOR, 2 wings, 3pth. 519-443-0063.

S-TINE CULTIVATOR, 12', pull type, rolling harrow & hyd cylinder, \$1000. 519-897-5534.

CIH TIGERMATE II, 30' low acres. 519-820-9666. Leave message.

GLENCOE/AGCO 3550 CULTIVATOR, 25', C-shank, 5R, 3 bar finger harrow, near new sweeps, rear hitch, double plumbed, exc paint & mechanical, \$7500. 519-820-9666. Leave message.

JD 980 CULTIVATOR, 36', C shank, 5 bar, Remlinger spike tooth harrow, \$16500. Don Skipper. 519-762-3244.

JD 1010 CULTIVATOR, 30'. 905-376-0281

10' CULTIVATOR, 3PTH, 2 furrow plow, 10' land roller. 613-929-4964.

COCKSHUTT #21 WALK BEHIND PLOW, good cond. 519-369-6082.

MCKEE S-TINE CULTIVATOR, 22' high clearance, 3 bar harrow, \$2500. 519-698-2200.

KONGSKILDE 18' CULTIVATOR, with double rolling harrows in good condition. 519-383-4084.

MULCH FINISHERS 7030

PONY CART HARROW, 23', with a winch & gague wheels on the wings, good cond. 519-799-5701.

PLOWS/RIPPERS 7040



CASE IH 7500 PLOW \$9500. B&M Agri Parts 519-323-4375.



CASE IH 720 \$3200. B&M Agri Parts 519-323-4375.

COCKSHUTT 3-FURROW PLOW, for sale. 905-230-0838.

MANDAKO MIN TILLAGE TOOL, 12' less than 200 acres. Other equip avail 905-985-2035.

2 FURROW INT PLOW, cat 1, 3pth. \$225. 705-844-1493.

KONGSKILDE OVERUM 5000 PLOW, hyd reset, hyd vari-width, new coulters & mouldboards, \$13000. 519-595-3722.

MH INT DRAG PLOWS, 3 furrow, good cond. 519-652-5393.

CASE IH DISC RIPPER, 5 shank, 7 in shovels tiger points, hyd lift disc gangs with scrapers, rock flex suspension, tandem walking wheels, spring reset, lights, exc cond, low acres, \$17900. 519-849-6684.

MF PLOW PARTS, like new, coulters/molboards, \$10. 519-462-2650.

FORD 151 SEMI MOUNT PLOW, 4 furrow, optional 5th furrow unit, good shape, \$1500, OBO. 519-784-0093.

OVERUM PLOW, 3 furrow, 3pth, like new! Must see! 519-462-2650.

FORD 140 PLOW, 3 furrow, never been used. 519-738-4349.

TRIPLE K PLOW, 5 furrow, hyd adjust, spring rest. 519-977-3335.

FORD PLOW, 2 furrow, good cond, call after 6 pm. \$200. 905-939-9076.

FORD PLOW, 5x18 w/ bust-er bar, good shape, Embro area. 519-475-4341.

INT 710 PLOW, 6 furrow. 519-849-6233.

MF 3 FURROW PLOW, 3 trip beams. 519-369-2098.

2006 JD 512 SHANK DISC RIPPER, good shape. \$15900. 519-384-1835.

MF 3 FURROW PLOW, 12" spacing, good cond, \$400. 226-271-5391, 519-866-3315.

JD 3 FURROW PLOW, 14" bottom, exc cond. 905-643-2423.

CASE IH 735 VARI-WIDTH PLOW, 5 furrow, exc cond, stored inside, del avail, serious inquiries only! Call or text. 705-328-8159.

JD 2700 PLOW, 4 furrow, auto re-set, 18', good cond, \$3000, OBO. 519-323-2643.

IH MCCORMICK PLOW, 3 furrow, fast hitch type, off Farmall 300, St Thomas area. \$400. 519-872-2188.

720 INT PLOW, semi-mount, 5x18, exc coulters, good wear parts, \$1750, OBO. 519-347-2451.

MASSEY PLOW, 2 furrow, 3pth. 519-485-0330.

ROTARY HOES 7050

ROLLING BASKET HARROWS, 10'x 6' smooth edge, \$200. 519-484-2633.

ROTARY HOE, 15', fair condition. \$800. 519-934-2722.

ROW CROP CULTIVATORS 7060

INT CULTIVATOR, 6R, rolling shields, good cond, \$1200. 519-688-8147.

S-TINE ROW CROP CULTIVATOR, 6R, 30" \$750. 519-791-2163 or (519-326-1262 evenings).

NOBLE 8R (6R) CULTIVATOR, good cond. \$500. 519-225-2887.

4R LILLISTON CULTIVATOR, \$500. 519-358-6405.

KVERNELAND 6R PLOW, tight, \$3900. 519-595-7180.

VERTICAL TILLAGE 7070

SALFORD RTS, heavy duty vertical tillage, 24', low acres, exc shape, \$40000. 519-524-0710.

JD 4430, CAB AIR, POWERSHIFT, 2WD, MINT CONDITION W/DUALS, RARE FIND, \$23000. O.B.O. Stepniak Bros, Ridgetown 519-674-0110.

OTHER 7090

DUNHAM LEHR PACKER, 24', flat fold, \$7000. 519-765-2064.

EINBOCK TINED WEEDER, 3pth, w/ seeder, rollers, 6 meters wide, very good cond, always stored inside. 519-482-3097.

GREAT PLANES, 30' hyd fold crumbler, lights, \$9500. Aylmer. 519-765-2064.

KILBROS, 37', hyd fold crumbler, dual wheels, lights, rear hitch & plumbed, \$9600. Aylmer. 519-765-2064.

AERWAY AERATOR, 12', pull type, good cond, \$6000. 519-538-2268.

TRIPLE K BEAN CULTIVATOR, 7R, with sheilds, \$650. 519-354-9584. After 6pm.

HEAVY DUTY PACKER, 21', hydraulic folding, flex coil. \$3500. 519-791-2163 or (519-326-1262 evenings).

FLEX PACKER, 7', heavy duty. \$500. 519-791-2163 or (519-326-1262 evenings).

KEWANEE FLEXIBLE DRAG HARROW, 18'. 905-541-4427.

CULTIVATOR SCUFLERS, front mounted, 4R, for INT, MH & Oliver. 519-436-4478.

15' WHEEL CULTIVATOR, Morris spring tooth harrows. \$925. 519-392-6079.

23' CROWFOOT PACKER, needs repair, \$2000. 519-359-5833.

ALLIED SPRING-TOOTH HARROW, 21', on wheels, good cond, \$750 OBO. 519-301-5001.

CROWFOOT PACKER, 6', \$650. 905-643-1402.

EINBOCK TINED WEEDER, 6mm wide, with grass seeder & rollers, exc cond. 519-485-0330.

40' LAND ROLLER, ETS 6 section with air bags, \$12500. 519-524-0107.

SPRING TOOTH HARROWS, 3PTH, \$150. 226-271-5391, 519-866-3315.

FLEURY BISSELL PACKER, 10', double axle. 905-939-2976.

2009 CASE TURBO TILL 330, 25', \$31000, Wil-Rich 657 DCR chisel plow, \$16000, RJ packer, 25' \$12000, RJ packer, 30' \$15000. 905-687-0365.

TRACTORS

4WD

8100



2390 CASE 6800 hours, good rubber. 160 HP. Runs great. \$9500. 519-503-1130.



2012 MF 2670 HD TRACTOR 4x4, DL260 Loader, cab/air/cd, 90HP, 312hrs, \$45000 or take trade. 613-549-7160.



MF 230 diesel, 3 point hitch, pto, power steering, good rubber. \$6200. 519-503-1130.



NEW HOLLAND T-6030 4wd, 3300 hrs. \$59,000. B&M Agri Parts 519-323-4375.



MF 285 diesel with multi-power, 6500 hours, pto, 3 point hitch, excellent tractor to drive, new paint. \$8500. 519-503-1130.



CASE IH 2188 4wd, good condition. \$49,000. B&M Agri Parts 519-323-4375.

1996 CASE IH 5250 MAXXUM, 4WD, 4850hrs, 18.4x42 tires, exc cond, \$39000. 519-887-6605.

1991 FORD 8730, 4WD, 20.8x38 tires with axel duals, 7900hrs, power shift, exc cond, \$32000. 519-887-6605.

MF 5460 TRACTOR, Dyna-4-Shuttle, FWD, Michelin tires, 3864hrs, exc cond, \$48000. 519-354-3636, 519-401-4304.

2005 CASE MXM190 TRACTOR, 10 front weights, 150PTO hp, Goodyear 20.8xR42 rearwith duals, 16.9R30 fronts, 18 spd p/s, 2400 hrs, \$80000. 519-939-3420.

JD 7810 TRACTOR, 2001 model, 4WD, pwr quad, 6000hrs. \$61000. 519-619-2779.

JOHN DEERE 8110, 4wd, 195 hp, 480/80-46, 420/90R30, 4 remotes, Greenstar, 10025 hrs, very good, \$67500, OBO. 519-301-2321.

JD 5525, 4WD, w/542 loader, 2005, 1950 hrs, exc cond. \$46000. 519-889-0150.

1993 CASE IH 5250, 4WD, 6000hrs, clean. \$32000. 519-889-0150.

JD 6420, FWD, cab, 24spd, power quad, new radial tires, 4780hrs, exc cond, \$55000. 519-354-3636 or 519-401-4304.

CASE IH 5130 TRACTOR, 4WD, C/H/A, powershift, 7250 hrs, 40km/trans, very nice, \$25800. 519-590-2698.

JD 8120 TRACTOR, 16 spd PS, 4 remotes, rear weights, heavy rear axle, 480x46 Michelin duals, auto steer ready, buddy seat. \$85000 obo. 519-421-5400.

KUBOTA M95XFWD, cab air, power shift, 540-1000 PTO, 1490 hrs, exc cond, \$38000. 519-354-3636 or 519-401-4304.

JD 3140 TRACTOR, 4WD, new tires, 2 remotes, \$14000. 519-820-9666. Leave message.

CASE IH 7220, 1996, 8636 hrs, 40 km, \$38000. 519-619-2779.

CASE IH MX 200, 2002, 6859hrs, new rubber, 50 km, \$56000. 519-619-2779.

JD 7230 TRACTOR, H340 loader, 4WD, 1450hrs, exc cond. 519-321-9233.

CASE IH MX110 TRACTOR, cab, 4x4, 3 remotes, 18.4R42 14.9R30, loader/bucket, 11500hrs, strong engine, new alt, \$25800. 519-590-2698.

MF 5455, 4WD, open station, 3400hrs, with loader, \$32500. 519-331-1804.

CHALLENGER MT 535B, CVT, cab, 4WD, \$41500 519-331-1804.

MF 50E, 4WD, cab & loader, \$14500. 519-331-1804.

JD COLLECTION, 27 2-cylinder tractors. 613-360-3710. 613-360-3710.

AGCO 5670, 1994, 4wd, 70hp, 3400hrs, \$16,500. Callaghan Farm Supply, Lindsay 705-324-8686

KUBOTA M7950DTC, CAB, 5700HRS, 12SPEED, \$16,000. Callaghan Farm Supply, Lindsay 705-324-8686

NH T7040 160 HP; CVT-50k; 3 mid & rear remotes, 2009, 5330 hrs. \$79,900. ESM Farm, Wallenstein 519-669-5176.

NH T7.270 195 HP; CVY-50K, 4 remotes, 2014, 2090 hrs. \$144,900. ESM Farm, Wallenstein 519-669-5176.

NH LS180 67 HP; CAB & HEAT, tires-80%, 2002, 8250 hrs. \$10,900. ESM Farm, Wallenstein 519-669-5176.

SUNFLOWER 21' VERTICAL TILLAGE DISC, LOW ACRES, EXCELLENT CONDITION, \$25500. Stepniak Bros, Ridgetown 519-674-0110

LOADER TRACTORS**8200****GET 0 INTEREST FOR UP TO 84 MONTHS****5 YEAR WARRANTY****ISLANDVIEW FARM EQUIPMENT**633520 Hwy 10, Orangeville
519.941.9098 • 1.866.892.8452**Mahindra**
Rise.www.islandviewfarmequipment.com**2015 / 4610 MASSEY FERGUSON**

99 Horsepower, 12x12 power shuttle. 18.4.30 rear, 12.4.24 fronts. \$479.01 per month. OAC.

Call for details

705-944-3333www.toddequipmentltd.com**Todd Equipment since 1951****KUBOTA BX25DTLB**
205HRS, PALLET FORKS, \$18,500
GJ'S - 519 424 9374**1994 JOHN DEERE 6300** Tractor, JD 640 loader, new front tires, powerquad. \$36,500. Howe's Farm Equipment 613-678-5599.**2012 CASE IH 75C** Tractor, nice shape, alo loader, 76HP, 2800hrs. \$35,500. Howe's Farm Equipment 613-678-5599.**WHITE 1370** 2 wd, loader. Call for pricing. DM Horst & Son 519-669-2520.**NH T7210 TRACTOR**, 855 TL loader, cv trans. 905-985-2035.**FORD 3600 DUNHAM LOADER TRACTOR**, diesel, 45hp. Clinton. 519-482-9255.**1965 DAVID BROWN LOADER TRACTOR**, red & yellow, c/w Elmira North American Snowblower, double auger, 3pth, \$5500. Will sell separate. 519-506-3358.**NH TS100**, FWD, cabin air, loader alloy quickie series 940, 5/L. 4500hrs, \$32000. 519-354-3636.**FARM TRACTOR LOADER**, quick attach, down pressure, controls & hoses. 519-699-5399.**WHITE FIELD BOSS**, 60hp, 2-60 front end loader & forks, works and runs well, sheet metal all there but some rust from sitting outside, \$5800 OBO. 905-537-6977.**585 CASE INT**, Cab & loader, exc cond, \$21000, OBO. 519-363-5255.**NUFFIELD 465 TRACTOR**, with loader, for parts, \$800. 519-323-2145.**JOHN DEERE TO TEST CAHRC A 35 IN** John Deere 5ft hay harvester pickup, slip clutch, chaindrive, front gauge wheels. manjiri.rampur@farms.com**1501 IH LOADER**, complete with valve, rebuilt, \$1000. 519-484-2807.**JD 1840 LOADER TRACTOR**, 4WD, 240 self leveling, 6' bucket, good cond, \$12000. 519-349-2747.**KUBOTA M6950**, 69 hp cab, 4wd, loader \$22000.00 Callaghan Farm Supply Lindsay 705-324-8686**KUBOTA B2100**, 1900hrs loader, 1996, 4wd, \$12000. Callaghan Farm Supply, Lindsay 705-324-8686**KUBOTA M7040DTHS**, 2012, 70hp, 2200hrs, Hyd shuttle, LA1153 loader, 2remotes, 16.9-28, \$34500. Callaghan Farm Supply, Lindsay 705-324-8686**JD 6420**, 2006, 110 hp, 5300HRS, 16PQ cab, 4wd, 640 loader, \$57900. Callaghan Farm Supply, Lindsay 705-324-8686**KUBOTA M7040DTHS**, 2009, 2000HRS, M20loader, one remote, \$34500. Callaghan Farm Supply, Lindsay 705-324-8686**NH BOOMER 50**, 47 hp, hydrostatic, loader, 2011, 805 hrs \$24,900. ESM Farm, Wallenstein 519-669-5176.**FORD 9030**, 105 hp, bi-directional, loader, frt pto/3ph, 1991, 3860 hrs \$39,900. ESM Farm, Wallenstein 519-669-5176.**OTHER****8490****CASE IH 7240 MAGNUM TRACTOR** 20.8R42 axle duals, front duals, 6,800hrs, MFWD, deluxe cab, mirrors, fenders, strobe front weights & hammer strap, exc cond, \$58,000. 905-229-9313.**MF 1135 TRACTOR** Perkins 6 cyl diesel, 120HP, 5600hrs, rebuilt motor at 4000hrs, power steering, good rear tires, metal good, runs exc, \$10900. 519-451-1966.**THE BEST PLACE FOR YOUR HYDRAULIC NEEDS** Hydraulic hose 1/4" to 2". Metric & standard fittings. Cylinder repair & sale. Ouimet Hydraulik, Glen Robertson Ontario, 613-874-2781.**FORD TRACTOR PARTS**

Specializing in 8N & 9N & 2N Tractor Parts & Engines Kits Plus other Ford Models and Manuals

- Steiner Parts Dealer -

Our 43rd year

1-800-481-1353www.diamondfarmtractorparts.com**1971 JD 4020 TRACTOR** with cab, syncro, turbo, new rear tires, 18.4x34, repainted two years ago, good working cond. 519-595-8946.



ZETOR 8011 TURBO Rebuilt engine, lots of horsepower. Good for tractor pulling in 7500 lb class and 10,500 lb class Has hi-low and PTO. Serious inquiries only call 519-468-3356.



FORD 5000 mechanic special. \$5500. B&M Agri Parts 519-323-4375.



IH 484 42HP, 2WD, Diesel, ROPS, 1-Remote, 540 PTO, 13.6 x 28" Turf Tires, 2715 Hrs. \$7900. Doughty & Williamson (519) 587-2273.



IH HYDRO 86 Diesel 15.5 X 38 tires, one of a kind condition Call for pricing. DM Horst & Son 519-669-2520.

INT TRACTOR WEIGHTS, 5-100lbs, \$100 each OBO. 519-807-1644.

IH 886 TRACTOR, diesel, TA torque amplifier, cab, 3715 hrs, 98HP, dual remote hyd couplers, dual speed PTO's, exc cond, please see kijiji ad id #115665515728 for pictures, \$13000. 705-559-5050.

FARMALL 105 U TRACTOR, cab, air, 1080hrs, exc cond, \$49000. 519-354-3636, 519-401-4304.

434 IH UTILITY TRACTOR, gas, many updates, exc running cond, OBO, \$3900. 905-797-2428.

DAVID BROWN 990 TRACTOR, diesel, 3pth, PTO, runs good, steering needs fixing, \$1500. Sudbury. After 7 pm. 705-662-0483.

FORD INDUSTRIAL LOADER TRACTOR, gas engine, good rubber, fresh paint, exc cond. \$4500, OBO. 519-347-2451.

KUBOTA 9580 TRACTOR, FWD, cab, 92hp, forward-reverse shuttle, 2800hrs, \$20000. 519-354-3636, 519-401-4304.



2 - IH 986 TRACTORS
Showroom Condition, \$19,000 on one and \$23,000 on the other.



IH 606
Diesel, Average Condition, \$4500



AC 180
Diesel, Real Sharp, \$8300



DAVID BROWN 1212
Engine problems, \$1800 C&C

AGRI-MOBILE
(905) 768-1493

AC 6080 TRACTOR, 2WD, \$7500. 519-354-3636, 519-401-4304.

NEW 2013 JD 72R TRACTOR, owner retiring, 200hp+107, premium cab, quad range, push button shift, no afterburner, 324hrs. 519-360-0312, 519-825-7138.

3000 FORD TRACTOR, diesel, 3 cyl, with new block heater, 14.9/24 turf tires, flat belt pulley, power steering, \$6000. 519-506-3358.

COLLECTION OF ALLIS TRACTORS, 200 Allis, cab, 3pth, pto, Allis D14, Allis I-400 w/industrial loader, Allis D17 w/loader. 519-392-8543 or 519-392-6633

2008 JD 8130, IVT trans, 4 remotes, 480x46 tires, rear weight, active seat, climatrak, MFWD, 5700hrs, \$130000. 519-421-5400.

INTERNATIONAL 504, gas, \$4500, OBO. 519-344-6003.

MH 30 TRACTOR, gas, for parts, \$450, OBO. 519-786-4372.

76 INT966, 3908hrs, \$15500. 519-384-1835.

JD 4020 TRACTOR, rebuilt motor, 2 remotes, Syncro trans, 2 new rear tires, cab, 3pth, 540/1000PTO, front weights, \$14500. 519-443-0063.

INTERNATIONAL 724, \$5500 613-387-3895.

INTERNATIONAL 140 TRACTOR older model, 1R cultivator, fertilizer side dresser, completely redone, good shape. 519-326-1770.

MH PONY, 32hp, new bearings included for back end to be re-assembled, runs well, \$1500, OBO. 519-928-5794.

444 IH INT TRACTOR CAB, engine has been rebuilt (100hrs), 2 syd remotes, PTO, pulley & hyd front guard avail, 6' McKee snowblower, \$6800. 519-376-9359.

AC 185 TRACTOR, 6900hrs, duals & front weights, expaint, new decals, \$4700. 519-440-8596.

WHITE 1470 TRACTOR, Good condition. \$7500. 519-538-2268.

JD 7730 TRACTOR, MFWD, 20spd, PQ, LHR, 3 remotes, 1925hrs, mint shape, \$125000 OBO. 613-353-2850.

2014 CASE IH 340 MAGNUM, 1340hrs, front & cab suspension, luxury cab, CVT, Michelin, 710/70R42 rear duals & 540/65R34 front duals, HID lighting, auto-steer ready. \$215000. 519-475-4482.

LONG 445 TRACTOR, 3pth, good tires, power steering, diesel, (like the Universal). \$2300. 519-758-4183.

INT 3588 TRACTOR, Diesel, 2+2, only 2300hrs, hardly used. \$19500. 519-791-2163 or (519-326-1262 evenings).

INT 656 TRACTOR, gas, 5000hrs, good condition. \$6500. 519-791-2163 or (519-326-1262 evenings).

DAVID BROWN 990, power steering, diesel, white in colour, exc runner. \$3250. 905-648-3793.

1948 LA CASE TRACTOR, for sale. 519-485-3344.

INT 154 CUB LO-BOY, turf tires, 3pth, snowblower, \$1699. 519-758-4183.

MCCORMICK TXH 165 TRACTOR 584hrs, 4WD, 650/38, 540/28, 3 remotes, 540/1000PTO, mint cond, stored inside, \$83000. 519-536-0352.

JD 7630 PQ, MFWD 20 spd, 3200 hrs, brand new 18.4x42 Michelins, will accept a trade. \$108000. 519-464-2855.

INTERNATIONAL 966, #76 model, 3903 hrs, \$15500. 519-864-1623.

CASE 1070 TRACTOR, dual wheels, power shift, dual remotes, 3PTH, 540/1000PTO, \$7000. 519-392-6079.

MF 270 TRACTOR, 1900hrs, new rear tires, \$9500. 519-820-9666. Leave message.

2013 MF 7620, CVT 50K trans, 4 front axle, cab susp, quick hitch, front weight rack, deluxe cab, 180 PTO HP, 365hrs, as new, \$141000. 519-820-9666. Leave message.

79 INT 886 TRACTOR, 2225hrs, \$14500. 519-384-1835.

MF 1010, diesel, 4 WD, hydrostatic drive with industrial 60" finishing mower, 3pth, 17HP, \$4500, OBO. 519-363-2685.

JD 7200R TRACTOR, 220HP, 324hrs, premium cab w/command centre touch display on RH console, axle duals Michelin R46, weights, quick-hitch, power quad, 4 SCV, Guidance ready, as new, owner retiring. 519-825-7138.

WD 45 ALLIS TRACTOR PARTS PTO shaft, gear box, hyd pump. 519-799-5701.

TRACTOR SCOOP, 3PTH, \$200. 226-271-5391, 519-866-3315

NJF MAGNATE MK II TRACTOR DRIVEN PTO AC GENERATOR, in perfect working cond, 25 kw, phase 1, 60 Hz, 104 Amps, 240/120 volts. \$2500. 519-870-2538.

MF 1080 TRACTOR, needs work, good tires. 519-698-1157.

1962 DAVID BROWN 950, needs-some work, diesel injection pump redone. 519-289-5968.

1968 MF 135 DIESEL TRACTOR, PS, MP, PC, indep PTO, PS wheels, new steering wheel, new rear tires, front weight frame, all metal sand-blasted & painted as new! Exc shape. 905-774-3034.

FARMALL H TRACTOR, all new tires, exc cond. 613-258-3561.

2-1989 FORD 3910 SU, 52hp 8 spd forward, 4 spd reverse tractors, hours 3528 & 4891. 905-689-4931.

JOHN DEERE TO TEST CAH-CA 35 IN John Deere 5ft hay harvester pickup, slip clutch, chandrive, front gauge wheels. manjiri.rampur@farms.com

1 WHEEL ASSEMBLY FOR FARMALL IH, fits M, 400 or 450, whole assembly. 519-392-6207.

FARMALL 300, 1956 row crop front, fast hitch drawbar, excellent metal, not running, complete tractor. St. Thomas. \$600. 519-872-2788.

ANTIQUE MCCORMICK DEERING TRACTOR Model 10-20 switched to rubber, restoration started, not seized. 519-410-1112.

2005 CASE MXM 285, 2400hrs, Pro 750 guidance system, \$114000, 2005 Case MXM 190, 3600hrs, \$74000. 905-687-0365.

JD TRACTORS, models 300 & 400. 519-665-2303. www.deereoldtractors.ca

RETIRING, 32 plate disc, 574 INT tractor, 7' bucket, 3 PTH plow, double PTO, 52" Bush Hog, total package, \$10750. 519-652-3940.

NH 8160, MFD cab, 2300hrs, \$24500. 519-331-1804.

NH 8160 90 hp, 4wd, C&A, 18x6 trans; 18.4R38, 1998, 7460 hrs \$31,900. ESM Farm, Wallenstein 519-669-5176.

TRAILERS

DUMP TRAILERS 8510



EX RENTAL 16 TON WEBERLANE DUMP TRAILER. Save big from new price. (519) 788-8866.

ALUMINUM DUMP TRAILER, 32', Tri-axle, roll up tarp, grain ready, safetied exc cond, \$13900, OBO. 519-688-8147.

ALUMINUM TANDEM DUMP TRAILER, 28', recent tarp, good cond. \$10500. 519-392-6079.

1984 KING ALUMINUM DUMP TRAILER, tandem, lift axel, plastic floor & sides, 36', tarp, good cond. 519-274-2527.

FLATBED TRAILERS /EQUIPMENT HAULERS 8520

FLAT BED TRAILER, low bed, 8'x15', duals, 900x20 tires, farm trailer safety sign, tongue jack, hauls 9 tons, Can Del. \$725. 519-236-4976.

MISKA FLAT BED TRAILER, 6 ton load rating, 16" wheels, with ramps, very good cond. \$2650, OBO. 519-758-4183.

6X16' FLAT BED TRAILER, 2- 3500lbs axles, double axles. \$2000, OBO. 519-446-3682.

HOPPER/GRAIN TRAILERS 8530

TRAILMOBILE GRAIN DUMP TRAILER, 22', good rubber, \$3500, OBO. 905-939-2693.

POST YOUR FREE FARMER CLASSIFIED

HORSE TRAILERS 8540

HORSE TRAILERS, Sundowner New 2h slant b/p, \$15,900.

HORSE TRAILERS, Sundowner New 16' stock b/p, \$13,900.

HORSE TRAILERS, Sundowner New 3h slant g/n, Super Sport, \$21,900.

HORSE TRAILERS, Sundowner new 2017 3h with 8' LQ, \$54,900.

HORSE TRAILERS, McBride '07 2h b/p, 7'6" tall, 6' wide saftied \$3050.



519-264-2354

2005 SILVERSTAR ALUMINUM HORSE TRAILER, 5th Wheel, 3 slat, tack room, good cond. 519-274-2527.

LIVESTOCK TRAILERS 8550

2010 FEATHERLITE LIVESTOCK TRAILER, 12', bumper pull, exc cond, 2/3rds of new price, \$9800. 905-985-6749.

UTILITY TRAILERS 8580



UTILITY TRAILER 5'x10' inside measurements, 2" ball, with brakes, \$1750, OBO. 905-929-7896.

UTILITY TRAILER, lightly used, \$650. 519-652-3940.

UTILITY DUMP TRAILERS FOR SALE. Tandem starting at \$5500, single axle starting at \$4450. Details call Orvie Martin, 519-510-3757.

OTHER 8590

2-6 STAGE HYD CYLINDERS, used for dump trailers. 519-365-5725.

FIFTH WHEEL FLOAT TRAILER 28' tri-axle, 8/14.5 tires, \$1000. 519-392-6079.

SINGLE AXLE TRAILER, 12'x7.5'. \$1900. 519-791-2163 or (519-326-1262 evenings).

TRI AXLE TRAILER, 16'x8', heavy duty. \$2950. 519-791-2163 or (519-326-1262 evenings).

2003 5TH WHEEL TRAILER, 28.5', 2 slide outs, stored inside, exc cond. 519-321-9233.

TRUCKS & AUTOMOBILES

CONVENTIONAL TRUCKS

8620

1967 CHEVY 5 TON TRUCK, 2 spd axle, 5 spd trans, will trade for 10 ton undercarriage without rack, \$1500. OBO. 519-506-3358.

1979 INTERNATIONAL TRUCK, 8x16' box with hoist, as is. 519-595-8946.

1994 PETERBUILT, as is, \$6000. 905-687-0365.

CONVENTIONAL TRUCKS WITH SLEEPER

8630

2003 PETE 379, 475hp, 18sp, 40th rears, 370 gears, full double frame, 400th on rebuild, new turbo, rad, starter, newer clutch, \$50000, OBO. 519-825-3751.

FARM/GRAIN TRUCKS - HEAVY DUTY

8640



51900 GRAIN / CATTLE / SILAGE TRUCK 1988, 19', new INT 466 motor, new Allison auto trans, new 40/60 3 hole grain doors, dump box, exc cond. cert, \$17500. 416-464-2373.

ALUMINUM DUMP TRAILER, 32', Tri-axle, roll up tarp, grain ready, safetied, exc cond, \$13900, OBO. 519-688-8147.

1998 INT TRI-AXLE DUMP TRUCK, 20' box, 8LL transmission, N14 Cummins motor, recently certified, in good shape. 519-925-8502, 519-939-8598.

1974 IHC INT GRAIN TRUCK, 20' tandem, 392 cu.in, 5x4 trans, 25 ton hoist, as is, \$2900. 905-376-0281.

1998 INT 4900 TANDEM GRAIN TRUCK, 21' grain box, silage tailgate, DTE 466 in good cond. 519-942-7159.

PICK-UP TRUCK 2WD

8660

2010 GMC SIERRA 1500, 2WD, approx 100000km, silver, vortex 4.8L, flex fuel, on star, ac/v8, 4/20/4 split front seat, locking rear diff, P245/70R 17' all season Michelin tire/sport alum wheels, new rims, new battery 2015, 4 snow tires/rims(1 season), \$19500. 519-236-4762.

PICK-UP TRUCK 4WD

8670

2004 DODGE 1 TON TRUCK, 4x4 Dually, diesel, 4 door, flat deck, runs and works good. \$8500. Sudbury. After 7pm. 705-662-0483.

2004 SUPER DUTY F550, Diesel, 16' aluminum van body, not winter driven, exc cond. 519-569-1779.

DODGE DAKOTA SPORT, 2002, 4-door, V6, automatic, good cond, \$2200 as is. 905-537-6977.

OTHER

8690

SOUTHERN USED TRUCK BOXES & NEW TAKEOFFS

new: 8' F250 Superduty Chev GMC & Dodge \$2995
Over 400 rust free used boxes in stock 73-2015 From Georgia
www.southerntruckboxes.com
NORFOLK TRUCK BURFORD ONT
519-802-7300

FACTORY WHEEL
Brantford, ON
Phone: 519-751-8540

22" GMC SIERRA WHEELS
P285/45/22 Firestone Destination LE2
SET OF 4 \$2995

20" SIERRA WHEELS
SET OF 4 \$1395

18" SIERRA WHEELS
SET OF 4 \$795

18" JEEP WRANGLER ALUMINUM WHEELS
P255/70/18 Bridgestone Dueler A/T tires
SET OF 4 \$995

www.factorywheel.ca

TRANSPORT LOG TRUCK, '96 Mack, CL 700, 5 axle, Tri Axle trailer, 13 spd, 48 rockwells, 8000 circle log loader, \$35000. Sudbury. After 7pm. 705-662-0483.

2007 DODGE GRAND CARAVAN, loaded, 4 captain seats, stow and go, DVD player, 4 snow tires on rims, 185000 km, \$4800 or trade for pick up truck. 519-365-7500.

1999 CHRYSLER INTREPID, safetied/e tested, V6, auto, 4 door, orig paint, new Bridgestone tires, 110000km, mint cond, \$2300. 519-365-7500.

WINTER TIRES, 4, Avalanche X-treme, 215/70 R15, \$150 for all. 519-699-9409.

1973 F600, with Gravity box & fertilizer auger, B.O. 519-347-2451

TRUCK BOX, 8' wide x 18' long x 9' high, with 2 openings, good cond, OBO, \$900. 905-797-2428.

1986 PONTIAC FIREBIRD, V6, fuel injected, 5spd standard, never seen winter, insured for \$9200, B.O. 519-475-4772.

1983 VOLVO, for parts or restoration, new complete muffler system & gas tank, good tires, tune up, repair manual. 519-839-4244.

JEEP TJ SOFT TOP, brand new, \$800. 519-983-6848 or 519-983-6400.

1976 1 TON CHEV, pull truck, 454 motor, 700HP, lots of extras. 705-772-6572.

A R E HARD TONNEAU COVER, fits Nissan Titan 2004-2012, grey, exc cond. 519-395-5080.

1956 FORD WESTERN TRUCK, exc body, 2 ton, factory dump flat bed steak bed, 1 owner, all original, \$7000. 905-699-8256.

1985 INT 1900, automatic, allison trans, snowplow hookup on the front, good tires. 416-288-0313.

MILITARY JEEP HARD TOP, fits model M38, metal doors, glass window, flip up back door with window. 519-799-5701.

TRUCK TOPPER, fits full sized pick ups, aluminum, \$100. 226-271-5391, 519-866-3315.

FIRE TRUCKS, Ford 700 pumper & 750 Louisville Pumper, off airport, low milage, gas powered, \$2500 each. White Expediter Cab over Pumper, detroit diesel, auto, \$3900. 519-758-4183.

WALINGA SEED TRUCK BOX DIVIDER, aluminum. 519-293-3420.

TRUCK CAP, 7' ARE, insulated, sliding windows; 100 gal. diesel fuel tank w/pump, hoses & elec hookup. 519-396-8196.

1993 INT DUMP TRUCK, SF2, tandem dump, Cummins, 13spd trans, 19.5' box with plastic floor, good cond. 519-274-2527.

CARS, 1974 Dodge Dart SE all original & 1965 Chevelle Malibu both 4-door. 519-665-2303. www.deereoldtractors.ca

1997 MERCEDES BENZ, 5 cyl, diesel, 4 door sedan, \$2000. 613-735-6602.

RECREATIONAL VEHICLES

ATVs & UTILITY VEHICLES

9100

J5 BOMBARDIER TRACK MACHINE, w/4 cyl GM auto trans, snow plow, cab rollover, spare parts. \$4000. Sudbury. After 7pm. 705-662-0483.

ATV TRAIL BLAZER, by BMG, model #170 STGb, 2WD, \$1500. 519-484-2633.

1980 HARLEY DAVIDSON GOLF CART, 3 wheels, good cond, runs good, gas, \$2000. 519-392-6079.

NEW MINI BIKE, gas powered, Briggs & Stratton engine, \$500. 519-758-4183.

ATV 2006 KAZUMA, 4x4 quad, 500cc's, needs a little TLC, \$550, OBO. 519-758-4183.

2-125 ATV'S, G10's, one orange, one black, \$800 each, ask for Dar. 519-785-1254.

2006 POLARIS SPORTSMAN 500 ATV, 4 new grip tires, electric winch, needs starter, in good shape. \$2500. 519-786-2033. After 6.

HURRICANE MOBILITY SCOOTER, 24V, new battery, 5yrs old, good cond, \$2500. 519-506-3358.

BOATS

9200

1979 THUNDERCRAFT 15', fiberglass boat, w/50hp Johnson and trailer, \$1300. 519-365-7500.

STEAM LAUNCH BOAT, oil fired, 23', 7' beam, compound engine, water tube boiler, to 15 PSI, heel condenser, 12V burner c/w alternator, hull seats 8, canopy w/ fringe, c/w twin axel trailer, \$9000. 519-371-5903.

MOTORCYCLES

9300

1995 YAMAHA VIRAGO, 1100, good cond, \$4000, OBO. 519-482-9902.

2015 ECOPED SCOOTER, white, signals/mirrors, 48V battery; chg time 8-10hrs, pedals, anti-theft alarm, double kick stand, 0-30km in 4-7 sec, top spd 32km, 350W motor/running, 500W motor/peak, 125kg or 275lbs cap. NEVER been used. 519-446-1806.

1975 SUZUKI GT185, model MCL, body type MS, vin # GT18521908, brown, 10000 miles. 519-799-5701.

RVs

9400

1977 YELLOWSTONE CAMPER, 26', sleeps 6, shower, fridge, cook stove, \$1300 519-365-7500.

1988 FORD HOLIDAYER 26', class C, 460 fuel injected, cruise, motor air & roof air, fridge is 3 way, battery, gas & electric, sleeps 6. \$15000 certified or BO as is. 519-475-4772.

SNOWMOBILES

9500

75 SNO JET 44 AIR FREE, snowmobile. 519-799-5701.

WANTED

WANTED

9800

WANTED: GRINDERS/MIXERS BOX SPREADERS & BALERS

- New Holland Square Balers
- New Holland Round Balers

Phone Neil
613-545-5281

WANTED: Lobsinger Brothers Pull Type Combine. 519-538-4929.

WANTED: Massey-Harris Tractor, reasonable price. 613-301-1747.

WANTED: Cultivator/ Plow for a Farmall A. 705-835-6749.

WANTED: CLASSIC MILKERS, with Dema Tron take offs, incl stall cocks, milking track. Markdale. 519-986-2841.

WANTED: Dorper Breeding Rams. 519-227-4882.

WANTED: Goats, Nanny Kids, 3-10 day old. \$125. each; Buck Kids, 3-10 days old. \$15. each. Will pick up-minimum group of 20. 905-932-5663.

WANTED: SEW & FEEDER PIGS, will purchase any size groups. Payment upon pickup. Ken 519-359-3462 or Hanneke 519-318-0897.

WANTED: CALF CREEP FEEDER, 519-227-4882.

WANTED organic farmer looking for manure. 519-275-4356.

WANTED: ADVANCE OIL PULL Advance Oil Pull Magazine, (Rumley), published monthly in 1920's & 30's or any other advertising literature or postcards pertaining to Rumley. 519-475-4165.

WANTED: BLUE CLAY, 519-383-4343.

WANTED: OLD GAS PUMPS, complete or just parts. 705-324-0920.

WANTED: TINE WEEDER, any size. 519-485-0330.

WANTED: Gas signs, oil signs, cans and pumps. 519-291-4924.

WANTED: Winchester model 12, 28 gauge, Winchester model 37A, 28 gauge, Winchester 37, 20, 28 & 410 gauge. 519-291-4924.

WANTED: Small Fridge, that can be used in barn for storing medications etc no larger than a 3' cube, no sunday calls. 519-688-5020.

WANTED: HAY, round bales & small squares. 519-923-9864.

WANTED: Large Square Bales, 2nd cut, high content of young timothy or orchard grass, must be good green colour for export, limited treatment. 416-464-2373.

WANTED: Certified organic wheat & barley for feeding hogs. 519-501-7553.

WANTED: ROLLOVER PLOW, 4 furrow, either 16" or variable width, good cond. 519-799-5701.

WANTED: Grain Dump Box, 20'-22', aluminum or steel, must be in good condition. 416-464-2373.

WANTED: THRESHING MACHINE any make. 519-538-4929.

WANTED: #38 NH CROP CHOPPER FLAIL HARVESTER. 905-983-9331.

WANTED: Grain bins & dump wagons, any size, full floor, stirator or hopper bins, good cond. 705-799-7262.

WANTED: CORN PICKER, any shape/cond. 519-365-5725.

WANTED: 2 row corn planters. 519-485-0330.

WANTED: New Idea 323 1R corn picker. 905-983-9331.

WANTED: INT GRAIN BINDER, 6' or 7'. 905-983-9331.

WANTED: SCUFFLER UNIT, 6R Hinniker or Yetter scuffler unit. 519-998-4200.

WANTED: MH hay tedder with steel wheels. 519-274-2527.

WANTED: Hay tedder. 519-323-1208.

WANTED: KUHN SPEED RAKE, 10 wheel. 705-232-4161.

WANTED, Finger wheel rake, 12 wheel, bi fold, in working cond. 519-835-3649.

WANTED: M#11 side delivery rake, on steel. 519-986-2841.

WANTED: 6' heavy duty finishing mower, 4 lg tires on corners, right side discharge. 519-799-5701.

WANTED: Round bale straw chopper, suitable for strawberries. 519-719-9810.

WANTED: Pull behind garden tractor, weed sprayer, 4' fold up boom, 50 gal tank, lg lid. 519-799-5701.

WANTED: MF yard tractor, hydrostatic transmission, 16HP, Kohher engine. 519-799-5701.

WANTED: Lasco electric weeder, or any info on one. 519-698-2098.

WANTED: NH OR GEHL GRINDER MIXER. 519-485-0330.

WANTED: Metal lathe, 6' bed. 519-436-4478.

WANTED: 12V FILL-RITE, fuel transfer pump & tank. 519-695-6613.

WANTED: Rear mount, 15' drill fill auger for Case IH 5400. 519-770-7551.

WANTED: CAB for Model 500 Belarus. 519-538-4929.

WANTED: VERSATILE 555, for parts. 519-377-6395.

WANTED: NO-TILL DRILL, with grass box. 519-383-4343.

WANTED: INT double disc seed drill & NH315 or 316 baler. 519-338-2691.

WANTED: Grass seed box for JD 750 No-Till. 519-338-5847 or 519-338-5228.

WANTED: 7' HD OFFSET DISC good cond. Eastern ON. 613-528-4502.

WANTED: Discs for IH scufflers that fit Farmall C or H. 519-698-2098.

WANTED: WEEDER/MULCHER, Int 2 point, for a fast hitch super c Int. 519-392-6207.

WANTED: Ford TW Series Tractors, for parts or in need of repair. 226-339-5791.

WANTED: ABS plastic canope to fit a model 2305 JD compact tractor. 519-799-5701.

WANTED: Plastic hood & side panels for JD 2305 HST compact tractor, good cond. 519-799-5701.

WANTED: 18' or 16' aluminum deck over trailer, removable side racks, good cond. 519-799-5701.

WANTED: IH 9300, semi highway truck or tractor. 519-482-9902.

WANTED: 1986-19990 Ford Ranger, pick-up, extended cab, stdn trans preferred, 5spd, good body. 519-291-4108.

WANTED: OLD FORD COUPE, 1940 or older, project or running. 905-699-8256.

WANTED: 6X6WD ARMY TRUCK, 5 or 10 ton diesel for parts; working or not. Sudbury. 705-662-0483 after 6pm.

WANTED: Indoor storage for 18' boat, 26'x10'x7' high, must have access to electricity. St. Catharines. Bob 905-932-3467.

WANTED: Skid Steer, 60" bucket, under 82" tall, make & age not important. 705-887-6845.

WANTED: 18' Wing-Fold Rock-Flex Finishing Disc, excond, narrow spacing if possible. 519-799-5701.

WANTED: LUMBER 2x6 & 2x8. Willing to dismantle or new. 519-501-9118.

WANTED: 7' HD OFFSET DISC good cond. Eastern ON. 613-528-4502.

WANTED: DISC PLOW, for Farmall A or B tractors, model #A-147. 519-392-6207.

WANTED: JD 7000 corn planter planting units or a complete planter or parts planter. 519-497-1386.

WANTED: Small loader tractor, in good working cond, will trade for 2007 Grand Caravan with snow tires. 519-365-7500.

WANTED: JD #37 loader with hydro bucket. 613-756-2789.

WANTED: JD TRACTOR JD Tractor for Sale mohit.bhatt@farms.com

WANTED: 1066 INT DOOR, left hand. 519-848-5244.

WANTED: 1850 COCKSHUTT CAB Wanted. 519-848-5244.

WANTED: Damaged tractors. 519-291-4924.

WANTED: 2PTH, For INT Super C. 519-393-6293.

WANTED: JD 420, 2 cyl tractor, wide front end, side sickle mower, 3pth, draw bar & PTO. 519-799-5701.

WANTED: GUNS, any type in any working cond. 519-348-8170.

WANTED: DION THRESHING MACHINE, with straw cutter, 22x38 or 28x48. 905-983-9331.

WANTED: 28x46 McCormick threshing machine w/ straw cutter. 905-983-9331.

Farms.com
Ag BUYER'S GUIDE

SELLING?

TEXT PICTURE & DIScription
226-212-0787

PUT NEW LIFE IN YOUR OLD EQUIPMENT.



RE-POWERING with a new Briggs & Stratton engine is affordable, reliable and better for the environment.



At Participating Dealers:
Call 800.663.9700 to Find the Closest Dealer Near You
or visit, www.briggsandstratton.com

JENSEN TRAILERS

SALES & SERVICE

ONTARIO'S #1 DEALER

1.866.479.1744 OSHAWA | JENSENTRAILERS.COM

SERVICE & REPAIR



CANADA TRAILERS LARGEST DEALER

JENSENTRAILERS.COM

CANADA TRAILERS

Full Line Manufacturer

- Dump Trailers
- Equipment Floats
- Tilt Decks
- Landscape / Utility
- Car Haulers
- Gooseneck & Fifth Wheel

Nation Wide Dealer Network

CANADA TRAILERS

Toughest Paint Job in the Industry

- Sandblasted Top to Bottom
- Phosphate Etched / Sealed
- Powder Coated
- Gas Oven Baked
- Scorpion Coat Stone Guard

CANADA TRAILERS



1.877.565.3714 | www.canadatrailers.com